

# IEET

## International Electrical Engineering Transactions

---

**Vol. 4 No. 2 (7)**  
**July-December, 2018**  
**ISSN 2465-4256**



**An online publication of the EEAAT**  
**Electrical Engineering Academic Association (Thailand)**  
[www.journal.eaat.or.th](http://www.journal.eaat.or.th)



## **IEET – International Electrical Engineering Transactions**

This journal is an online publication of the EEAAT, Electrical Engineering Academic Association (Thailand). IEET is published twice a year, ie., the first issue is for January – June and the second issue is for July – December.

### **EEAAT Journal Committee**

Athikom Roeksabutr (Chairman)  
Apirat Siritaratiwat  
Kosin Chamnongthai  
Prayoot Akkaraekthalin

### **IEET Editors**

Somchai Hiranvarodom  
Boonyang Plangklang

IEET (International Electrical Engineering Transactions) is published twice a year. Original contributions covering work in all aspects of electrical science, technology, engineering, and applications will be peer-reviewed by experts before publication. Topics of interest include the following: electrical power, electronics, telecommunication, control and system, sensor and measurement, optical technology, computer, information and communication technology (ICT), signal processing, social network tools and applications (apps), engineering education and other related fields.

For online submission of all manuscripts, correspondences, and letters, please visit  
**[www.journal.eeat.or.th](http://www.journal.eeat.or.th)**

### **IEET Editorial Office**

EEAAT - Electrical Engineering Academic Association (Thailand)  
Room 409, F-Building, 140 Cheum-Sampan Rd.  
Nong Chok, Bangkok, Thailand 10530  
Tel: +662-988-3655 ext 2216 Fax: +662-988-4026

## IEET - International Electrical Engineering Transactions

Volume 4 (7)

Number 2

July – December 2018

(Special issue in STEM (Science, Technology, Engineering, Mathematics) Education)

### PAPERS

Development of Student Outcome: A case study of project-based learning in Math III for undergraduate engineering students	Prapanporn Rattana Nuttapong Prasertsung	59
Designing and Evaluating English Language Tasks for Engineering Students	Suthee Ploisawaschai Surasak Suriyasri Sarasin Boonmalert	64
Integrated-Project-Learning: A case study of pilot implementation on sound quality and Fourier series	Banyat Lertprasert Tejtasin Phiasai Kanteera Soontharapiratkul Prapanporn Rattana	69
Learning Development By Using Peer Assisted Learning: A Case of Residential College	Nuttapong Prasertsung Mai Noipitak Sukanlaya Tanitiwaisawarujj	74
Emotional Analysis of Elementary Students with and without Learning Inefficiency Using an Emotion Detecting Application	Rodel D. Estamo Ephraime Xezpyr L. Godinez Patrick Andrew Pelias Fritz Laurence R. Villacorta Ralph P. Laviste	78
Spaced Learning: Electrical Concepts First, Complex Processes Second Reducing the time taken to teach concepts to maximize time for complex processes	Ewan MacRae	85
Understanding Radiation Improvement in Electrically Small Dipole and Loop Antennas Using Perturbed Two-Wired Transmission Line Model	Apisak Worapishet	90
Condition Assessment of Synchronous Generator Using Fuzzy Logic	Maninder Choudhary Thanapong Suwanasri Suphon Kumpalavalee Phanupong Fuangpian Cattareya Suwanasri	99

# Development of Student Outcome: A case study of project-based learning in Math III for undergraduate engineering students

**Prapanporn Rattana**

Mathematics Module  
King Mongkut's University of Technology Thonburi  
Ratchaburi, Thailand  
Prapanporn.rat@kumtt.ac.th

**Nuttapong Prasertsung**

King Mongkut's University of Technology Thonburi  
Ratchaburi, Thailand  
Nuttapong.pra@kmutt.ac.th

**Abstract**— This study aims to reveal the effectiveness of using a 'project-based learning' instructional model in Mathematics (MTH III) course. The project used in the course titled 'Applying vector calculus for electric field'. The participants were selected by purposive sampling method. There were 5 groups out of 22 groups of the second-year engineering students at Ratchaburi Education Centre, King Mongkut's University of Technology Thonburi. In this study, the instruments used are 1) instruction model used in Math III: project-based learning and 2) the knowledge, problem solving and communication skill assessment or KPC assessment. By analyzing the results using sampling t-test method, it has been found that the participants have improved their achievement test scores in three main facets; KPC. The students have scored 84.38 percent in average K. As for P and C, the students have scored 82.95 and 86.01 percent in average respectively. The findings illustrate that students' achievement scores of each aspect were significantly higher than the criterion of 80 percent at the 0.05 level.

**Keywords**— *project-based learning; vector calculus; student outcome*

## I. INTRODUCTION

Mathematics is considered as one of the core subjects for engineering students. For completing engineering studies, the students are required to have mathematical knowledge. Therefore, it is challenging for the instructors in teaching and dealing with learner's learning progress. To the extent of the learning progress, in order to assist students, the instructor need to help them understand basic mathematics and know how to apply in engineering studies. Moreover, students' achievement assessment should be considerably designed to guarantee students' optimal abilities in mathematics and their competency in integrating knowledge learnt to engineering fields. So, the various scholars from different studies were interested in investigate the progress of developing mathematical knowledge and skill for solving engineering, mathematics competency needed for engineering students [1-2].

Since 2013, Ratchaburi Education Centre, King Mongkut's University of Technology Thonburi (KMUTT RC) had been found that the teaching programs were designed as modules in

order to improve the engineering student's ability and competency so-called 'Modular Instruction'. This instruction consists of 4 modules: Mathematics, Chemistry and Materials, Electric and Mechanics. All modules were incorporated into the programs to enhance engineering students' knowledge and learning skills. Problem-based learning was also used in KMUTT RC in a way that it was applied in each program. As a result, these instruction lead students to know how to apply mathematical knowledge to the real-world contexts: community service, or outreach program.

To the extent of mathematics module, the instruction was designed in concordant with KMUTT RC's concept. To have a good mathematics learning result of engineering students, certainly, a new teaching approach was introduced to use in mathematics module. The new approach was modeled for teaching and assessment. It was adapted from the traditional teaching method in a way that the students have to study in a large classroom lecture in order to get the concepts of mathematics theories. After that, the students will be separated for studying in groups (10-15 people per group), which can be called as tutorial-style learning. The idea is to provide an opportunity for students to discuss and communicate with each instructor easily and directly in a small group setting. The problem-based learning was also applied in this teaching method through the project [3]. By doing so, problem-based learning could lead students to have motivation in order to learn [4].

In terms of students' achievement assessment, the instructors teaching for mathematics module have evaluated students' performance based on three main aspects which are 1) Knowledge skill, 2) Problem-solving skill and 3) Communication skill or these aspects are known as KPC [5]. K represents knowledge. K is used for measuring the understanding of key concepts and techniques of mathematical manipulations and computations. P stands for problem solving, is used for measuring students' analytical skill on the problem to provide mathematical problem-solving strategy. And the last letter is C, which is abbreviated from communication. It is mainly focused on students' communication skills, for example, the students must be able to explain, write, read and express their thoughts smoothly and intelligibly. The

mathematical problem-solving process in obtaining the solution. KPC has led the researchers to design students' assessments elaborately which consists of written examinations, which was a traditional assessment for higher education. It was used for midterm and a final examination. Oral, essay and project, which were more modern than written examinations [6], used in students' achievement assessment as well. As for project session, the project was assigned by Mathematics module instructors involving in Electrical and Mechanic modules. The students had to run a project which was related to those modules mentioned earlier so-called 'Integrated Project'. By doing so, the students could apply mathematics knowledge learnt, side by side, with engineering basis knowledge to their everyday life.

From aforementioned information [3,7], it can be seen that the mathematics module instructors have been highlighting on project-based learning. According to Sa Ngiamsunthorn's study [3], the researcher used project-based learning for promoting learning process of engineering students at KMUTT RC, the study reveals that the students achieved high scores in a final exam. It was found that the students tended to have higher scores for the test's items related to the topics they chose during the project. As for students' attitudes, the findings from the interview illustrates that the students had positive attitudes towards project-based learning. The students stated that project-based learning could help having understanding of mathematics concepts as well as building up an understanding of real world problems.

In this study, integrated project-based learning will be highlighted. It was a cooperation contribution between mathematics and electric modules designed to measure second-year KMUTT RC students' ability of 'Vector Calculus' for MTH III course, for the first semester of the academic year 2017. Instructional model, lesson plan, assessment and marking criteria were constructed by mathematics module instructors. However, project design, electric experiments were constructed by both module mathematics and electric. The components of this study were divided into three main parts: section II objectives, section III methodology, section IV the results and discussions and section V conclusions and suggestions.

## II. OBJECTIVES

To investigate students' achievement scores in MTH III for engineering students at KMUTT RC after being assessed by criterion assessment KPC based on project-based learning approach. The core of the present study was project which titled 'Applying vector calculus for electric field'. Apart from the project usage, 'the project advisor system' was also taken into account.

## III. METHODOLOGY

The participants were 5 groups or 28 participants in total out of 22 groups or 112 participants. This study is related to learning achievement assessment by project advisor system.

So, the sample groups were selected by purposive sampling in a way that these groups shared the same advisor.

### o Teaching Approaches

In MTH III class, all students had to study vector calculus both in a lecture class and small-groups class. So, students understood mathematics theories: gradient, divergent and curl. Moreover, they also had an opportunity to practice calculating for solving mathematics problems based on learning outcome planned by the teaching team. Project-based learning approach used in class was designed by the instructors to show students the relationship between mathematics and fundamentals of electrical engineering. After that, students used theoretical mathematics in order to explain the electrical phenomena including discussion on the solution to problems that occurred during the experiment. Students also had opportunities to interact with their friends and advisors throughout the project. They also trained themselves in further research in finding information from other sources. The students proceeded their project in the following order:

Teaching team clarified the learning objective and procedures for working with students

In the electrical laboratory, students experimented the electrical experiments to find an equipotential line from the self-made conducting sheet

Students used mathematical knowledge and mathematical software Matlab to take data from an equipotential line to generate a potential function and calculate the gradient of the potential function as well as find the divergence of the electric field.

Students described electrical and mathematical phenomena as well as expressed opinions regarding the problems that occurred and how to solve them and then reported progress to the project advisor for the first time.

The learner creating a video clip to summarise a working process.

The learners reported progress for the second time by presenting the video clip to the project advisor. Then the project advisor gave comments on improving students' work.

Students edited and revised the video based on the project advisor's comments and submit their work.

Teaching team measured and evaluated students according to the criterion assessment.

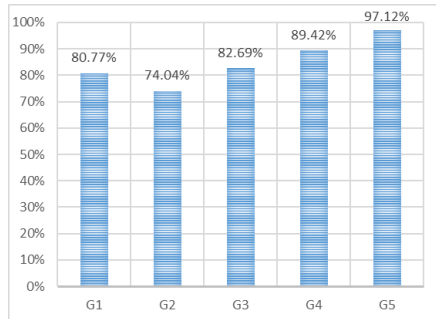
### o Assessments

In this model of teaching, the assessment was designed by using marking rubrics based on the criterion assessment KPC. The rubrics related to KPC were used for evaluating students' videos. The evaluation was conducted by the teaching team of mathematics. Two instructors of the teaching team evaluated

one video of one group. The average score was transformed to the final score.

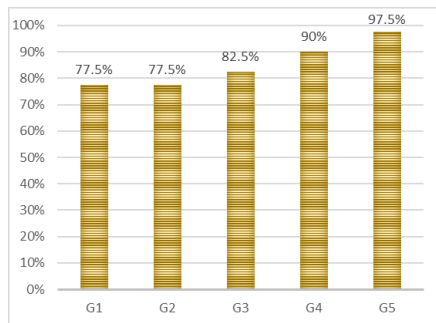
#### IV. RESULTS AND DISCUSSIONS

In this section, Math III learning achievements of 28 students from the sample group will be discussed. The students from the sample group were divided into five groups and the detail will be clarified in this section. The scores which were the final score were collected from the mathematics module.



**Fig. 1.** The students’ learning achievement scores from each group after being taught by project-based learning approach

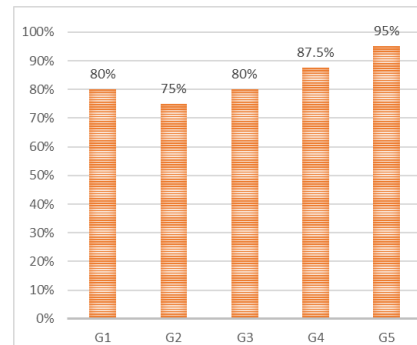
Figure 1 illustrated the students’ learning achievement scores after being taught by project-based learning approach in Math III. From the figure, group 5 (G) has achieved the highest scores or 97.12 in percentage. In the meantime, group 2 (G2) has received the lowest scores or 74.04 percent in total.



**Fig 2.** The students’ learning achievement of knowledge skill from each group after being taught by project-based learning approach

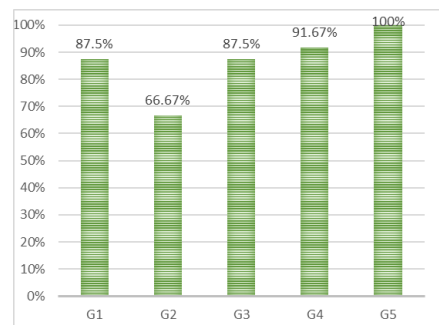
According to Figure 2, it can be seen that after studying through project-based learning, students from different groups achieved various scores for learning achievement in relation to knowledge skill. From the figure, group 5(G5) has achieved the highest scores or 97.5 in percentage. In contrast, group 1(G1) and group 2(G2) has got the lowest scores or 77.5 percent in total. It can be seen that project-based learning could promote and support knowledge exchange among learners. Moreover,

learners could expand knowledge in their knowledge bank. They could gain knowledge not only in the classroom but also from peers. Furthermore, they understood the relationship between the content for completing the project and other subjects: mathematics and electric.



**Fig 3.** The students’ learning achievement scores of problem solving skill from each group after being taught by project-based learning approach

Figure 3 showed the students’ learning achievement scores in terms of P. From the figure, group 5(G5) has achieved the highest scores or 95 in percentage. However, group 2(G2) has received the lowest scores or 75 in percentage. It can be seen that project-based learning could promote and support knowledge exchange among learners. Moreover, learners could discuss and brainstorm in the group. Moreover, they could critically analyse information gained as well as discuss reasonably based on mathematics theories.



**Fig 4.** The students’ learning achievement scores of communication skill from each group after being taught by project-based learning approach

For learning achievement regarding C as shown in Figure 4, group 5(G5) has achieved the highest scores or 100.00 in percentage. However, group 2(G2) has received the lowest scores or 66.67 in percentage. It can be concluded that project-based learning could promote interaction between an instructor and students in the class. Therefore, students could



communicate with peers and the instructor properly based on mathematics theories. Moreover, they had a chance to learn more about making video clips throughout completing the project, improve themselves in communication skills and have confidence in speaking.

**Table 1.** The students’ learning achievement scores from each group after being taught by project-based learning approach

N	$\bar{X}$	S.D.	$\bar{D}$	S.D. <sub>D</sub>	t	Sig.(1-tailed)
28	84.81	7.69	3.97	7.69	2.68*	0.0061

Overall, all 28 participants achieved the average score of 84.81. It can be concluded that students’ achievement scores of each aspect are significantly higher than the criterion of 80 percent at the 0.05 level as shown in Table 1. According to the criterion assessment KPC, the scores for each skill is statistically significant in a way that students achieved high scores which is higher than the criterion of 80 percent at the 0.05 level. KPC scores are divided into three main aspects which are K with the average score of 84.38, P with the average score of 82.95 and C with the average score of 86.01, as shown in Table 2.

**Table 2.** The students’ learning achievement scores of KPC from each group after being taught by project-based learning approach

N	Skills	$\bar{X}$	S.D.	$\bar{D}$	S.D. <sub>D</sub>	t	Sig.(1-tailed)
28	K	84.38	7.72	4.38	7.72	3.0*0	0.003
	P	82.95	6.97	2.95	6.97	2.24*	0.017
	C	86.01	11.24	6.01	11.04	2.83*	0.004

For the students’ follow-up process, in the first consultation progress report, it has been found that students from all five groups consulted with the project advisor. During the consultation, students could explain problems and obstacles occurred during the experiments in the electrical laboratory. Besides, students analysed the results of the experiment by using Matlab program. They also could set the plan for solving the problems logically. In terms of advisor-student interaction, the advisor could encourage individuals to participate in expressing opinions about their work. In the second progress report, there was only group 5(G5) that had performed the task and submitted a video clip to the project advisor. By doing so, the students from this group was able to improve the video clip based on the advisor’s comments. Eventually, the students from this group achieved the highest score on all three KPC skills compared to the other four. The students also scored 100 percent in C, as shown in Figure 1-4. From this result, the achievement of the students from group 5 was considered very

high. On the other hand, group 2(G2) received the lowest grade which was C. According to the fact that group 2 did not follow teacher’ advice for improvement. Also, they did not report the progress to the advisor. So, the students from group 2 had problems in many areas: 1) lacking understanding of the contents, 2) lacking problems solving skills and 3) lacking ability of analyse data. The problems were reflected in a form of scores which were lower than the instructors expected as shown in Figure 1.

V. CONCLUSION AND SUGGESTIONS

This study aims to reveal the effectiveness in using the ‘project-based learning’ instructional model in MTH III course. The findings reflect the achievement of engineering students based on the criterion assessments. Besides, the findings show a model for instructional development. In this previous section, the participants from the sample group achieved the same number of scores which was 84.81. It was significantly higher than the criterion of 80 percent at 0.05 level. After using project-based learning, the students’ achievement of each KPC criterion was significantly higher than the criterion of 80 percent at the 0.05 level. The result of this study is in line with Suparat Chanman [8] and Rapeephan Suthapannakul[9]. Chanman(2013) studied ‘Effect of E-learning Using Project-Based Learning in Learning Achievement and Collaborative Behavior of Undergraduate Students, Faculty of Education, Silpakorn University’. The study aimed to investigate learning achievement scores before and after using project-based learning. The result of the study reveals that learning achievement scores for Innovation and Technology course after studying was significantly higher than the criterion at the level of 0.01. In the same way, Suthapannakul(2014) conducted the research under the topic, ‘The Development of Technical English Reading Instructional Model Focusing on Task and project-based learning to Enhance Reading Comprehension and Creative Thinking of Undergraduate Students’. The aim of this study was to study the effectiveness of the Technical English Reading Model focusing on Task and Project-Based Learning. And the students’ reading comprehension achievement after using the developed teaching model was significantly higher at the 0.05 level.

In conclusion, from the study, the study indicates that students will be able to develop their own potential in terms of KPC by receiving feedbacks from others. That is to say, the students’ follow-up process so-called ‘project advisor system’ should be highlighted. In order to develop students according to the KPC criteria, working on the project is a good way to support the achievements. For further study, the researchers recommend that report progress to the project advisor should be highlighted as a compulsory activity. It would be better if all groups of students have a mutual understanding that reporting progress is a compulsory activity. Due to the instructors’ instructions, report progress was not highlighted so there were four out of five groups which achieved the low scores.

## ACKNOWLEDGMENT

We would like to thank all teaching team both mathematics and electric modules for their data support. We also would like to express our appreciation to Prof. B. Sirinaovakul for many useful discussions.

## REFERENCES

- [1] M. Niss, "Mathematical competencies and the learning of mathematics: The Danish KoM project," In: A. Gagatsis; S. Papastavridis (eds). Proceedings of the 3rd Mediterranean Conference on Mathematical Education. Athens: Hellenic Mathematical Society, 2003, pp. 115-124.
- [2] P. Kent, R. Noss, D. Guile, C. Hoyles and A. Bakker, "Characterizing the use of mathematical knowledge in the boundary-crossing situation at work," *Mind, Culture, and Activity*, 2007, pp. 64-82.
- [3] P. Sa Ngiamsunthorn, M. Tanasittikosol, and S. Yoo-Kong, "Bringing the Real-World Context into Mathematics : A Case Study of Project Based Assignment in Elementary Calculus for Engineering Students," *iSTEM-Ed 2016 conference*, Pattaya, Thailand, 2016, pp. 77-79.
- [4] P. C. Blumenfeld, E. Soloway, R. W. Marx, J. S. Guzdial and A. Palincsar, "Motivating Project-Based Learning: Sustaining the Doing, Supportin the Learning," *Education psychologist*, vol. 26, 1991, pp. 369-398.
- [5] C. Varsavsky, D. Kig, C. Coady, and K. Hogeboom, "maths assess A guide to implementing criteria based assessment in undergraduate mathematics," *Parryville Media*, Sydney, 2014.
- [6] B. Gold, S. Z. Keith, and W. A. Marion, "Assessment practices in undergraduate mathematics," *The Mathematical Association of America*, Washington, DC, USA, 1999.
- [7] P. Rattana, T. Phiasai, S. Yoo-Kong, and P. Sa Ngiamsunyhorn. Criteria "Assessment in Elementary Calculus under Competency Based Learning : A Case Study of Below Benchmark," *iSTEM-Ed 2017 conference*, Chiang Mai, Thailand, 2017, pp. 138-141.
- [8] S. Chanman, "Effect of E-Learning using Project Based Learning in learning achievement and collaborative behavior of undergraduate students, Faculty of education, Silpakorn University," A Thesis submitted in partial fulfillment of the requirements for the degree Master of Education program in Education Technology Department of Educational Technology Graduate School, Silpakorn University, 2013, pp 176.
- [9] R. Suthapannakul, "The Development of Technical English Reading Model Focusing On Task And ProjectBased Learning To Enhance Reading Comprehension and creative thinking For Undergraduate Students," A Thesis submitted in partial fulfillment of the requirements for the degree doctor of philosophy program in curriculum and instruction graduate school, Silpakorn University, 2014, pp 4.



# Designing and Evaluating English Language Tasks for Engineering Students

Suthee Ploisawaschai, Surasak Suriyasri, Sarasin Boonmalert

Department of English  
Mahanakorn University of Technology  
Bangkok, Thailand  
sutheeplo@icloud.com

**Abstract**—This paper presents the findings from designing and evaluating English language tasks for engineering students in an English course. These tasks were done in the specialized course of English for Engineering and followed the Task-Based Learning (TBL) approach. The key features of TBL are that each smaller task should form part of a larger project and reflect real-world language use through active learning and interactive engagement. We designed as well as assigned tasks to students and then evaluated their task performance and learning achievements based on three aspects: (1) task completion, (2) task engagement, and (3) language use in tasks. Regarding the student opinions towards this TBL course, it was rated at the highest level. Sample works will be shown in this paper.

**Keywords**—Engineering students; English language tasks; Task-Based Learning (TB); English for Engineering; English for Specific Purposes (ESP)

## I. INTRODUCTION

For STEM education, there are many approaches to teaching and learning in higher education, for example, active learning, problem-based learning (PBL), project-based learning (PBL), constructionism, and constructivism. These approaches are popular among disciplines where students pursue their degrees in STEM, such as engineering, technology or science. It seems that these students learn their subject contents with a different approach while many English language classrooms still follow the linguistic approach with language tests. Therefore, this paper examines one approach to teaching and learning called Task-Based Learning (TBL) which has been used in an English classroom for engineering students at a university in Thailand.

TBL is relatively new in English language classrooms compared to the grammar-translation method. Normally, an English classroom is about grammar points and then learners have to do tests related to those grammar points. Therefore, it can be said that many English language classrooms followed a kind of Test-Based Learning approach. However, it was found that language tests based on grammar did not always help students succeed in communication in a foreign language situation because grammar-based tests focus on specific areas

of language use while tasks focus on overall proficiency of language use [1]. In a Spanish language program, it was found that task-based learning helps adult learners increased their overall proficiency quicker than grammar-based learning and tests [2]. In the context of Thailand some university students failed to cope with their English courses successfully when the assessment was based on grammar tests because they were weak language learners. Besides, these students did not have a positive attitude towards English language classroom since they felt anxious to speak and communicate in English and they saw their English competence as an indicator of their personal success or failure [3]. To tackle with these problems, researchers at King Mongkut's University of Technology Thonburi (KMUTT) initiated task-based learning approach to their English classrooms to help engineering students change their attitudes towards English so that they were more confident in their use of English. [4]

In this paper, the researchers (we) will talk about how we have tried to go beyond tests in our specialized English classrooms so that learners can engage in tasks as part of their study and how we evaluated their task performance and learning achievements. Then, we will reflect on the advantages and the limitations of this TBL approach.

## II. LITERATURE REVIEW

Before the TBL approach is discussed in details, it is important to understand what a task is. There are many definitions of the word "task" and given below are definitions taken from authoritative dictionaries:

- A task is an activity which is designed to help achieve a particular learning goal, especially in language teaching. (Oxford Advanced Learner's Dictionary of English) [5]
- A task is an activity or piece of work which you have to do, usually as part of a larger project. (Collins Cobuild Advanced Learner's English Dictionary) [6]
- A task is a piece of work to be done, especially one done regularly, unwillingly or with difficulty. (Cambridge Advanced Learner's Dictionary of English) [7]
- A task is a usually assigned piece of work often to be finished within a certain time. (Merriam-Webster's Collegiate Dictionary) [8]

According to the above-mentioned definitions, we may redefine a task as “an activity which is designed or assigned to language learners to do regularly or to finish within a certain time in order to help them achieve a particular goal as part of a larger project”. It should be noticed here that there are a few important elements of TBL as follows:

- A task is done regularly.
- A task is to be finished within a certain time.
- A task helps learners to achieve a particular goal.
- A task is part of a larger project.

These features of TBL are highlighted in the literature and here are some other features proposed by scholars in the TBL approach:

TBL in English classroom is different from a linguistic approach in that a linguistic approach focuses on the analysis of elements of the linguistic system and these elements are taught separately whereas a TBL approach focuses on how learners can make use of their language proficiency to perform tasks. In order to achieve tasks, learners are required to engage in three things as in procedure, process and task (or work) [1].

TBL requires learners to pay more attention to meaning and to use their own linguistic resources in order to simulate a real-world language use, either directly or indirectly [9].

TBL must be both active and interactive to be a successful approach. Learners are active when they invest mental energy and labor in their task and the classroom is interactive when there is an interaction (or feedback) among learners in the same group and between learners and teachers. Therefore, it is suggested that TBL is not just about one task but many “tasks”. In other words, there should be three kinds of task for learners as in (a) pedagogic task, (b) target task, and (c) assessment task [10].

According to the above-mentioned features of TBL, it is important that English classrooms at a university level should follow the TBL approach because it helps learners to engage in the activities and to perform tasks which are similar to their real-world use of language.

### III. METHODOLOGY

#### ○ *The Design of English language tasks in the English for Engineering course*

This research was based on one course entitled “English for Engineering” and the target requirements were that the learners could understand and use English in the contexts of their future workplace (engineering industries). The tasks which were designed and assigned to students would come with an example so that learners had these as an input and they had a few opportunities before they actually did their own tasks during their free time before submitting their final output.

#### ○ *The Engineering Students*

There were 50 second-year and third-year undergraduate students in the English for Engineering course which was run in the third semester (summer) of the academic year 2016.

#### ○ *The Evaluation of English Language Tasks*

The term “task” in TBL is not just about one task but it is about many tasks because these tasks will form part of a larger project. Therefore, each small task assigned to learners would be given feedback by teachers before they finally submitted the final output. To evaluate the task performance and learning achievements, the researchers set criteria regarding language use which included: (1) task completion; (2) task engagement; and (3) language use in task or final output.

#### ○ *Data Collection and Analysis*

The data in this research were all the tasks given to the researchers by the undergraduate students. In this particular course, there were 3 main tasks. Each small task done by students would be given feedback by teachers before the students finally submitted the final output. Each final output would be scored from 0 to 10 according to the following criteria:

- Task completion (2 points): If the final output is completed, each task will get 2 points.
- Task engagement (2 points): If any member of the group could answer the questions raised by the researchers, such task will get 2 points.
- Language use (6 points): We used three aspects of language use [11] to evaluate the language use of the students and these were vocabulary (lexis), accuracy (word forms) and structure (grammaticality). Each aspect would be rated for 2 points.

### IV. FINDINGS

In this section, we will present our findings in three aspects as in (1) the tasks we designed and assigned to our learners; (2) the evaluation of those tasks done by learners; and (3) the opinion of the learners towards the TBL course.

#### ○ *Tasks Assigned to Learners*

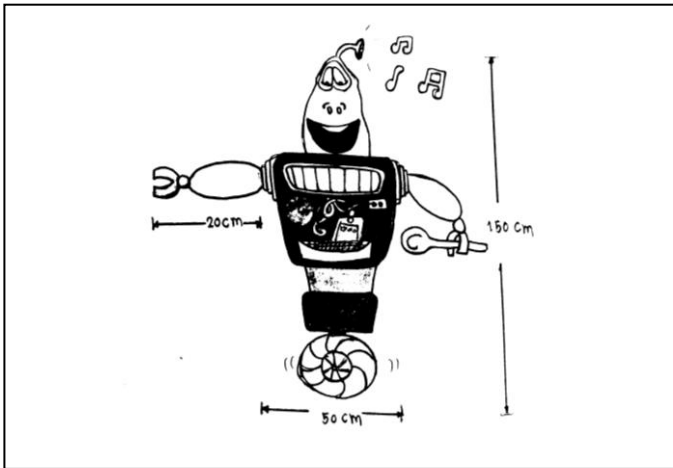
There were many tasks we designed and assigned to our learners. In the English for Engineering course, we told our learners that each task would form a part of a larger project, that is, the Rube Goldberg mechanism. To do so, we began with these smaller tasks:

Machine (what it is like and what it does; shapes, dimensions, and functions). See Fig. 1.

Console with buttons and functions (what kinds of buttons are required, where buttons are in the console, what functions these buttons do; locations and instructions). See Fig. 2.

Mechanism (similar to machine but with many events from the beginning till the end; a series of events). See Fig. 3.

Learners have freedom to draw and design their machine. However, the task target is that the learners have to be able to use English language to describe shapes, dimensions and functions of their machine. Learners were given example sentences to describe things and they used those structures to guide their own creativity and language production.

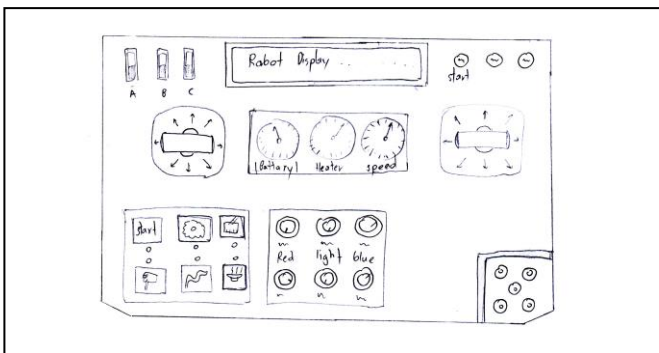


**Fig. 1.** Machine (shapes, dimensions, and functions)

Based on Fig. 1 which is a drawing by one group of students, these are some of the statements which the students wrote to describe the shapes, dimensions and functions of the machine.

- Larva Robot is 150 cm high.
- His body has the width of 50 cm.
- His arms has an oval shape.
- He can move by his wheel.

After the learners had finished that task (shapes, dimensions and functions), the next task for them was to design their own console to control the robot. The learners had to write statements to describe locations of buttons and instructions for users. Fig. 2 shows a console with many buttons and what these buttons do.



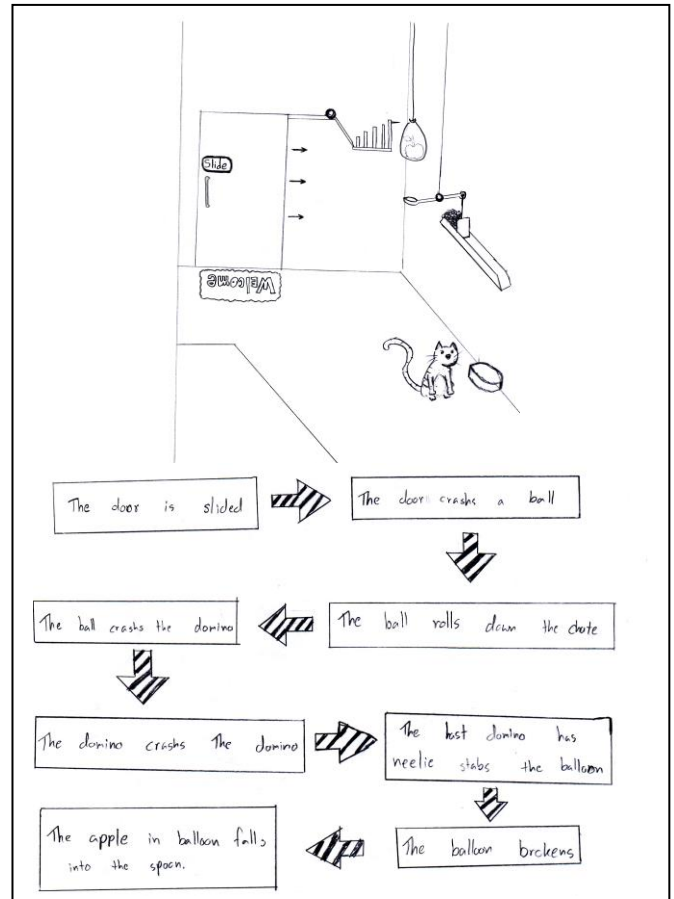
**Fig. 2.** Console and buttons (locations and instructions)

Based on Fig. 2 which is a drawing by another group of students, these are some of the statements which the students wrote to describe locations and instructions of these buttons:

There is a LCD display at the top in the middle. LCD display is for showing message.

There are three gauges in the center. Gauges are for beauty.

The third task for the students was to write a series of events to describe a mechanism from the beginning to the end. They had to explain how these events were related to each other. Fig. 3 is a drawing by a group of students and it shows a series of events to describe one mechanism to feed a cat.



**Fig. 3.** Rube Goldberg Mechanism (a series of events)

Based on Fig. 3, the statements which the students wrote to describe a series of events are given below:

When the door is slid, the door crashes a ball and the ball rolls down the chute. After the ball crashes the dominos, the last domino with needle pierces the balloon. The balloon explodes and falls into the spoon. Then the spoon gets heavy and it rotates. The spoon lifts the gate and the pet food flows on the chute. As a result, the pet food falls into the bowl.

o *Task Evaluation*

Here are three main questions we used to evaluate the tasks done by the students:

- Do the students complete the task?
- Do the students engage with the task?

Is the language use acceptable?

With the first question, all students who came to class completed their tasks, both individually and as a group. Before they submitted the final product, they had to study and practice the language use within the scope of each task in the classroom alongside the model. Then, they did those tasks outside the classroom.

Regarding the second question, we checked the student engagement with tasks through feedback time. When the students did their task as a group work, we randomly chose any name in the group to answer the particular questions to check their engagement. The students who could neither answer nor give any comments regarding the questions would be marked as those with less engagement with the task. To illustrate, Fig. 2 shows three gauges in the center and we would ask any students in the group what these gauges were for.

As for the third question which is about the language use, we checked the accuracy and their ability to perform the task. We had to admit that the language use by these students was not perfect. However, it indicates that these learners are developing their language skills through usage. To illustrate, Fig. 3 begins with the statement: “The door is slid”. In other words, the learners did not know that the correct form of “slide” is actually “slid”, not “slided”. This incorrect use shows that the learners were trying to make use of passive structure to make a distinction with the active structure in the second event: “The door crashes a ball”. Therefore, this group got full mark for their language use although their language use is not perfect..

o *Student Opinions towards the Course*

Table 1 shows the student opinions towards the English for Engineering course in their last session.

**Table 1.** THE STUDENT OPINIONS TOWARDS THE COURSE

<i>Item</i>	<i>Mean</i>	<i>S.D.</i>
The course covers essential topics.	4.68	0.52
The teachers are able to give a clear explanation.	4.51	0.64
The learner has learned how to think.	4.54	0.60
The learner can ask the teachers, both inside and outside the classroom.	4.59	0.71
The course material is suitable.	4.63	0.54
The course assessment is suitable.	4.44	0.81
<b>Total</b>	<b>4.57</b>	<b>0.64</b>

According to Table 1, the average student opinion towards the course was at the highest level (mean score is 4.57, S.D. is 0.64). They considered that the course covered essential topics, that the course material is suitable and that the learners can ask the teachers, both inside and outside the classroom. Still, the item with the least agreement level was the course assessment. The reason was that some students did not have time to do their tasks outside the classroom time, either because they had to do

part-time jobs or because they had too many assignments from other courses.

V. DISCUSSIONS

In this paper, we have presented the findings from designing and evaluating English language tasks in the English for Engineering course which was run in the third semester of the academic year 2016 and there were 50 undergraduate students.

We designed our English language tasks based on the concept that each task must form part of a larger project. Moreover, each task was accompanied by a model so that the students were aware of the target requirements and the model was like a pedagogic task before the students submitted their final output.

To evaluate these tasks, we focus on three aspects as in (1) task completion, (2) task engagement and (3) language use in tasks.

Regarding the task completion, all students had submitted their tasks. Therefore, TBL is a good alternative to test-based learning in that students are more likely to do a task at their own free time before they submit it to the teachers. Based on the student opinions towards the course, they felt that they were able to ask questions both inside and outside the classroom so that they could perform their tasks better. It might be implied that these students become active learners through this approach because they felt that teachers were there to help them, not to judge them. Moreover, tasks are often seen as enjoyable activities and therefore the completion rate was high [12]. It was also reported in [4] that tasks and preparations before the actual main task could reduce the student’s anxiety. In this case, students were able to finish their tasks in time and they enjoyed these creative tasks.

Regarding task engagement, it is important to note that when a task is assigned individually and each student has freedom to think creatively, the task experience is very engaging. This experience was similar to the one described in [13] where teachers no longer dominate the classrooms and the assignments. In other words, tasks help create a learner-centered environment where learners could perform these tasks on their own.

Regarding the language use in tasks, we have found that students were developing their language skills through tasks. Although their language use was not perfect, they were trying to make use of their language proficiency to perform tasks well enough to be understood. This is an indication of a good effect which TBL offers to an English course. In the Thai context, it was reported that accuracy was the area which Thai students often overlooked when they performed their tasks [4]. In other words, their language use was not free from errors. We hope that when learners practice more, their language will be better.

There are some limitations of English language tasks in this study. First, there is a ‘just-do-it’ behavior without checking the instructions. For each task assigned, a few students tended to ignore explanations and failed to meet the requirements. In other words, they might just do as though they fully understood the instructions and the expectations set by the lecturers. When



they got feedback about their mistakes, they then realized that they did not follow the instructions given.

Second, there is a 'just-translate-it' attitude without developing the language proficiency. Some students used machine translation on their mobile phones when they had to write English statements. The negative impact of this practice was that they could neither remember any words nor fully engage in the tasks during the feedback time. The use of cell phones in the classroom was raised in [14] to point out that cell phones could be useful language learning tools. However, these online information technology devices could disrupt the students' attention during their task activities. Moreover, cell phones did not help these students retain their memory of the language use. However, it is reported in [15] that when task-based activities and computer-assisted language learning are combined and integrated, the learning and teaching experience in an English classroom will be more innovative, interesting and enjoyable. This might be a direction for future research.

## VI. SUGGESTIONS

Based on our study, we make the following suggestions for use and for future research studies:

Tasks help learners to fully engage with their language activities and they reflect their real-world use of English. The tasks are also a channel for the learners to display their creativity. Still, we need to cope with the 'just-do-it' behavior and the 'just-translate-it' attitude when students engage with their task activities.

Tasks should be used in general English courses in order to help learners move beyond linguistic analysis of language towards language use and proficiency. Learners will have more opportunities to use their language and the lecturers can give feedback to students to improve their linguistic proficiency.

Tasks and technology should be integrated and taught together in a course so that learners know how to use technology effectively rather than mere machine translation which results in their inability to remember any vocabulary or structure.

## REFERENCES

- [1] M. H. Long and G. Crookes, "Three approaches to task-based syllabus design", *TESOL Quarterly*, vol. 26, pp. 27-56, Spring 1992.
- [2] M. Gonzalez-Lloret and K. B. Nielson, "Evaluating TBLT: The case of a task-based Spanish program", *Language Teaching Research*, vol. 19, pp. 525-549, September 2015.
- [3] R. Koul, L. Roy, S. Kaewkuekool and S. Ploisawaschai (2009). "Multiple goal orientations and foreign language anxiety", *System*, vol. 37, pp. 676-688, December 2009.
- [4] W. Singhasiri and K. Thepsiri, "Teachers' Beliefs about Task-Based Language Teaching for Science and Engineering Students", in *Innovation in Language Learning and Teaching: The Case of Thailand*, P. Darasawang and H. Reinders, Eds. Hampshire: Palgrave Macmillan, 2015, pp. 89-108.
- [5] Oxford Advanced Learner's Dictionary of English, 9th ed., Oxford: Oxford University Press, 2015.
- [6] Collins Cobuild Advanced Learner's English Dictionary, 5th ed. Glasgow: HarperCollins, 2006.

- [7] Cambridge Advanced Learner's Dictionary of English, 3rd ed. Cambridge: Cambridge University Press, 2008.
- [8] Merriam-Webster's Collegiate Dictionary, 11th ed. Springfield, MA: Merriam-Webster, 2003.
- [9] R. Ellis, *Task-Based Language Learning and Teaching*. Oxford: Oxford University Press, 2003.
- [10] K. Van den Branden, *Task-Based Language Education: From Theory to Practice*. Cambridge: Cambridge University Press, 2006.
- [11] P. Skehan, "Task-based Performance and Task-based Instruction: Research Contributions", *JALT Task-based Learning SIG*, May 2014.
- [12] M. Calvert and Y. Sheen, "Task-based language learning and teaching: An action-research study", *Language Teaching Research*, vol. 19, pp. 226-244, March 2015.
- [13] K. Van den Branden, "The Role of Teachers in Task-Based Language Education", *Annual Review of Applied Linguistics*, vol. 36, pp. 164-181, March 2016.
- [14] P. J. Kiernan and K. Aizawa, "Cell phones in task based learning – Are cell phones useful language learning tools?", *ReCALL*, vol. 16, pp. 71-84, May 2004.
- [15] K. Anwar and R. Husniah, "Evaluating Integrated Task Based Activities and Computer Assisted Language Learning", *English Language Teaching*, vol. 9, pp. 119-127, April 2016.

# Integrated-Project-Learning: A case study of pilot implementation on sound quality and furier series

**Banyat Lekprasert**

Ratchaburi Education Center  
King Mongkut's University of Technology Thonburi  
Ratchaburi, Thailand  
[banyat.lek@kmutt.ac.th](mailto:banyat.lek@kmutt.ac.th)

**Kanteera Soontharapirakkul**

Ratchaburi Education Center  
King Mongkut's University of Technology Thonburi  
Ratchaburi, Thailand  
[kanteera.soo@kmutt.ac.th](mailto:kanteera.soo@kmutt.ac.th)

**Tejtasin Phiasai**

Ratchaburi Education Center  
King Mongkut's University of Technology Thonburi  
Ratchaburi, Thailand  
[tejtasin@gmail.com](mailto:tejtasin@gmail.com)

**Prapanorn Rattana**

Ratchaburi Education Center  
King Mongkut's University of Technology Thonburi  
Ratchaburi, Thailand  
[prapanorn.rat@kmutt.ac.th](mailto:prapanorn.rat@kmutt.ac.th)

**Abstract**—This study presents the students' achievement and student opinion from the integrated-project between physics and mathematics. The project was designed based on the selected topic, quality of sound in physics and Fourier series in mathematics. The activities aim to offer not only knowledge but also experience real world problem solving. The results show that students understand the concept of quality of sound and application of Fourier series as assessed by instructors from both physics and mathematics. Students' satisfaction also showed that more than 50 percent of students have a positive opinion in 7 categories in our study. Moreover, student self-motivation and teamwork which are 2 of 7 categories were satisfied from 80 percent of all students.

**Keywords:** *integrated-project, quality of sound, Fourier series, students' satisfaction*

## I. INTRODUCTION

In recent years, many educational ideas have been discussed widely in preparing students to be competent with a set of the 21st-century-skills. Not only professional knowledge is a key success in their future carrier. But various human skills are also important. This paradigm shift requires changing in pedagogy [1-2].

Traditional lecture is the main stream model of learning and teaching in engineering currently. This approach has remained unchanged for decades with "chalk and talk" in a large class and single-discipline style. Students have to study passively with less opportunity to interact with the lecturer and other participants in the class. Many types of research have been studied to improve active learning activity in the classroom [3]. They, however, focus on delivering knowledge contents. Using the only lecture may not be an effective model for constructing essential 21st-century-skills on students.

Project-based and problem-based learning (PBL) approach helps students to learn knowledge-based contents as well as assist them to construct more soft-skills into their knowledge [4-6]. By incorporating with some assisting tool, for example, e-portfolio, could provide a good learning environment for both students and instructor [7].

Development of a learning environment at King Mongkut's university of Technology Thonburi, KMUTT (Ratchaburi) to help students in constructing their professional knowledge together with soft-skills requires a new learning pedagogy alternative to traditional lecture. Project-based learning is also one of a potential approach that can be applied. However, based on our prior experience, the learning and teaching through the project activities demand huge resources for not only students but also instructors. A broad spectrum of knowledge related to the project and extra period of time is required for both instructors and students to achieve the project's goal at the end. The situation would be more difficult when each subject gives individual complicated project assignment to students in the same semester.

In order to reduce students' workload and to share resources among subject, an integrated project-based learning has been proposed at KMUTT (Ratchaburi). The idea is to design the project activity to which all related topics of knowledge are distributed to teach and learn in associated courses. Students can focus on one final goal and be more concentrate on applying most of the related knowledge they have learnt from associated courses to finish their tasks. Multiple expected learning outcomes together with soft-skills can be assessed throughout the associated classes. The idea had been applied at KMUTT (Ratchaburi) in 2016 to pilot the feasibility of implementation.

This action research aims to report the experience on the implantation of a project-based activity by integrating math and physics on first year students at KMUTT (Ratchaburi). The assessment scores to which students achieved in both physics



(mechanics) and mathematics, together with students' opinions on this learning style are discussed in detail.

## II. METHODOLOGY

This section is divided into two parts that are the sound quality analysis and the learning process.

### o Sound Quality Analysis

This process will study the properties of a sound signal that includes an amplitude and a frequency in the time domain and frequency domain. The sound signal will be analyzed based on the Fourier series (FS) and the Fourier transform (FT) techniques. The Fourier series analyzes the signal in time domain to explain the frequency components of the signal that includes each harmonic frequency as shown in (1).

$$f(t) = a_0 + \sum (a_n \cos(n(2\pi f)t) + b_n \sin(n(2\pi f)t)) \quad (1)$$

The equation (1) is the Fourier series equation that is used to analyze a periodic signal ( $f(t)$ ). The  $f(t)$  is the summation of cosine and sine functions of each frequency. For a non-periodic signal, the Fourier transform, as shown in (2), is used to analyze the properties of  $f(t)$ .

$$F(f) = \int_{-\infty}^{\infty} f(t)e^{-j2\pi ft} dt \quad (2)$$

A result of (2) is a complex number form that is in the frequency domain and the power spectrum of its will be calculated to show the relation between a magnitude and a frequency.

The analysis process to find the frequency of any signals showed in Figure 1.

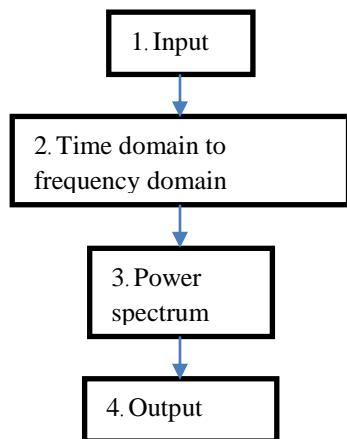


Fig. 1. The process of Frequency Analysis

Each step in Fig. 1 can explain the following.

Step 1: The signal in time domain is analyzed to find the properties in the frequency domain. For an example, the sine wave has a period of 0.2 seconds, as shown in Fig. 2, is loaded.

In this step, a discrete signal is created by the sampling frequency (Fs) with the Nyquist theorem.

Step 2: The sine wave in the 1<sup>st</sup> step is transformed, from the time domain to the frequency domain. A mathematical tool that is used in this step is the Fast Fourier Transform (FFT) and the result of this step is the complex numbers.

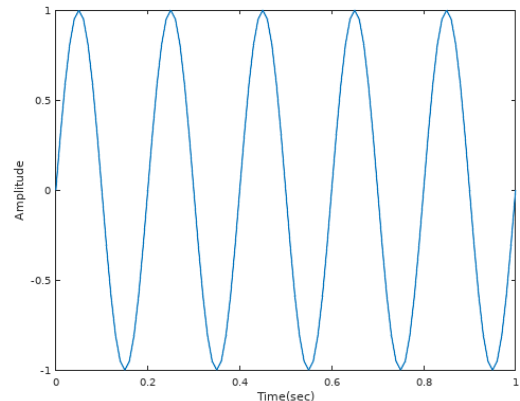


Fig. 2. The sine signal with a period 0.2 sec

Step 3: In this step, the result from FFT in the 2<sup>nd</sup> step is used to calculate the power spectrum of the signal in term of the relation between the magnitude and frequency of the analyzed signal as shown in Fig. 3.

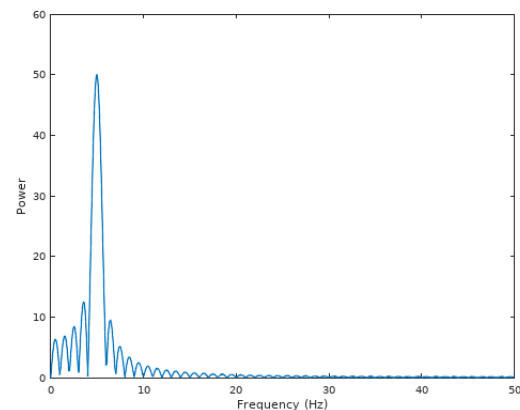


Fig. 3. The power spectrum of the sine signal at 5 Hz

Step 4: This step reports output frequency of the analyzed signal in the 3<sup>rd</sup> step. The output frequency is a frequency point that has a maximum magnitude. In Fig.3, the maximum magnitude at approximately 50 units corresponds to the frequency point at approximately 5 Hz.

### o Process of Learning

This process explains the use of the frequency analysis diagram as shown in Fig. 1 for student learning as the following.

Step 1: Divide the students and lectures into many groups. The lecturer is group adviser of the project.

Step 2: Give the two frequency signals, such as 300 Hz and 600 Hz, to each group for analysis. The output graph of each frequency has to be demonstrated.

Step 3: Each group records the sound from each musical instrument as an input of the process as shown in Fig.1 and discusses the result of the output frequency.

Step 4: Each group writes a report and give a presentation to the lectures.

Step 5: Each group give a feedback to the questionnaire for evaluating their satisfaction of the project.

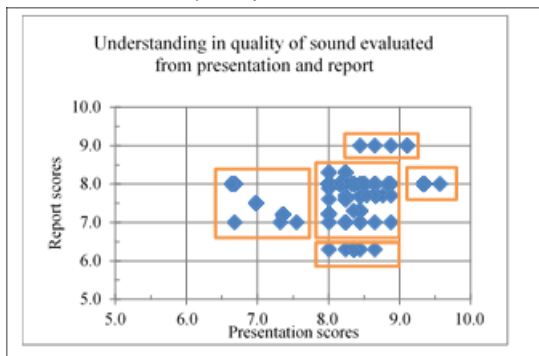
### III. OBJECTIVES

The main objective of this study is to analyze the results of integrated-project-learning of students' achievement both physics and mathematics via the topic of quality of sound and to evaluate the students' satisfaction as using to provide the ways of teaching improvement for the next episode.

### IV. RESULTS AND DISCUSSIONS

In this section, the results are studied from both physics and mathematics scores. In terms of students' assessment, their marks were evaluated from the presentation and report in an independent manner of physics and mathematics. The questionnaires were designed to evaluate the students' satisfaction after finishing the project. Students understand that their opinion did not affect the assessment scores.

#### o An Analysis of Mechanics Score



**Fig. 4.** Students' understanding of the quality of sound evaluated from presentation and report

Fig. 4 shows a scattered plot of students' scores evaluated from presentation and report. The horizontal axis represents scores obtained from the presentation and the vertical axis represents scores obtained from the report. The marking score scales from 0 to 10 for both report and presentation. Learning assessments were performed based on students' response in expressing their knowledge about the quality sound and the application of Fourier series. As can be seen in figure 4, students' scores locate in a high region. The presentation scores range approximately from 6.5 to 9.5. The report scores range approximately from 6 to 9. The higher the scores imply the

better understanding of the related topics. This apparently high score may contribute to the fact that students' response was satisfactory. Most of the expected key ideas were expressed by students in their presentation and report. Furthermore, as this activity was a group assignment, students could share their ideas with a colleague. This helps them to select a more appropriate response in both presentation and report allowing them to obtain high marks.

Not only knowledge in the quality of sound in fundamental university physics and Fourier series in mathematics is reflected from the activity. Some crucial soft skills, particularly, communication in topics of science and engineering can also be explored. As shown in fig. 4, the scores locate in clusters which may be classified into 5 groups. The first group locates in the middle of the scattered plot which may represent the moderate range of score (8.0 to 9.0 for presentation and 6.5 to 8.5 for report). The majority of students belong to this category. An ability to communicate their understanding about the quality of sound in the oral presentation is as good as by writing in the report. This group is used as a reference for discussion. The second group locates under the referent group to which the presentation score is moderate while the report score is slightly low (less than 6.5).

Students who are categorized in this group could express the key concepts of the quality of sound in an oral presentation. Communication through writing, however, is not as good as their oral express and students should have more practice to improve their writing skill. The third group locates on the left of the referent group. Presentation scores for students in this group are slightly low compare to the referent one (less than 8). This indicates that they are able to communicate their ideas in writing fairly. But, their oral communication skill is slightly lower than the others. This may contribute to preparation and levels of knowledge at giving a presentation. Students who are well prepared could deliver presentation messages systematically. Also, students who understood clearly in the concepts of quality of sound and Fourier series could have well response instantaneously to questions from audience allowing them to acquire higher scores. The fourth and fifth groups locate above and on the most right of the referent group respectively. These groups are the students whom can perform satisfactorily in presentation together with a good ability to express their understanding in writing (the fourth group). This is also similar to the fifth group. Not only an ability to write reports as good as the referent group, they do also have distinguishable oral presentation skill. All groups of students could be learnt more by introducing session to which they can share their learning experience from this activity to students in the other groups.

#### o An Analysis of Mathematics Score

In this section, the learning achievement of engineering students in relation to mathematics module will be discussed. To measure students' learning achievement, the students' assessment system is needed to be used. The assessment was

designed to be in consistent with the mechanic module in a way that students' ability was evaluated based on presentation and report. However, the achievement assessment procedures of the mathematic module are significantly different from mechanics. To the extent of the mathematic module, the achievement assessment is learning outcomes-based assessment focuses on evaluating three main competencies: the knowledge (K), problem solving skill (P) and communication skill (C). To be clarified, K stands for knowledge. As for its concepts, K is used to measure the understanding of key concepts and techniques of mathematical manipulations and computations. P represents problem solving which is used for measuring students' analytical skill on the problem to provide mathematical problem-solving strategy. C is from communication. It is mainly focused on students' communication skills, for instance, students' ability to explain, writing, reading and expressing their thoughts smoothly and understandably. In this KPC criterion, engineering students are expected to explain and describe mathematical definitions, Fourier theorems, and Fourier series correctly. That is to say, the learning outcomes are 1) students will be able to express their understanding of the application of Fourier series for measuring the quality of sound, 2) students' Problem-solving skill will be improved and 3) students will be able to relate quality of sound with mathematics knowledge. So, in each semester, students should be able to form Fourier series equation consisting a given physical phenomenon. Moreover, the instructors expected that students can adapt mathematical techniques to solve quality of sound problems and then define mathematical results for explaining the original physical meaning. Finally, in terms of communication skill, it is the competency for measuring the ability to express ideas and solve mathematics problems properly, rationally, and accurately. For accuracy, students have to solve mathematics problems correctly based on mathematical principles: writing correct mathematical symbols and appropriately giving an oral presentation. So, KPC scores were incorporated both in presentation and report sessions.

Fig. 5 illustrates students' scores based on KPC assessment evaluating only presentation and report. It is found that students could achieve overall score about 80% for knowledge, problem solving and communication skill. Moreover, it can be seen that students have increased communication skill which was higher than at the beginning of studying from 0 % to 88.50%. This result was reflected by the marking criterion. Figure 5 also shows that students could achieve 80 % scores which are considered high for all of KPC aspects. From very high scores, in can be concluded that students have the ability to create mathematical equations. They also could define the quality of sound correctly and accurately. Besides, they could express their understanding

in researching and calculating to solve mathematics problems. Lastly, students could understand and define the physical meaning of quality of sound in terms of Fourier series clearly. Regarding communication skill, all students masterfully expressed a clear mathematical terminology and notation in a written and explained the concepts and the logic to solve the problem together in an oral presentation.

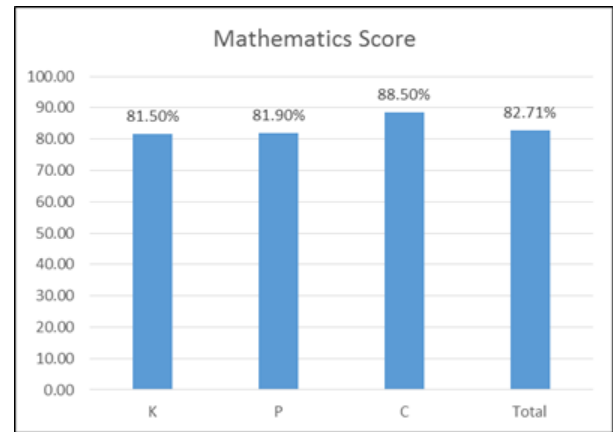


Fig. 5. The average percentage score based on the KPC criterion.

o *An Analysis of Student 's Satisfaction Score*

In this section, students' satisfaction was explored by using the questionnaire. The questions were designed to explored students' learning attitude in 7 categories: self-motivation, ability to apply knowledge, understanding cross-subject relation, students' attitudes, teamwork, an organization of project and mentor's role. The students' satisfaction rate was measured by a five-point Likert type scale from strongly disagree to strongly agree.

Based on the data analysis of 7 students' learning attitude categories, more than 50% of all students were satisfied with all categories as shown in figure 6 (A-G). The student self-motivation and teamwork have the greatest impact on students more than 80%. Some observations supporting the assumption that the project is designed to apply theoretical knowledge and provide "hands-on" experience. It was necessary for the student to spent extra time on self-study. Moreover, the project was a good study tool which was done by teamwork. Developing positive relationships between student is a fundamental aspect of quality learning and working.

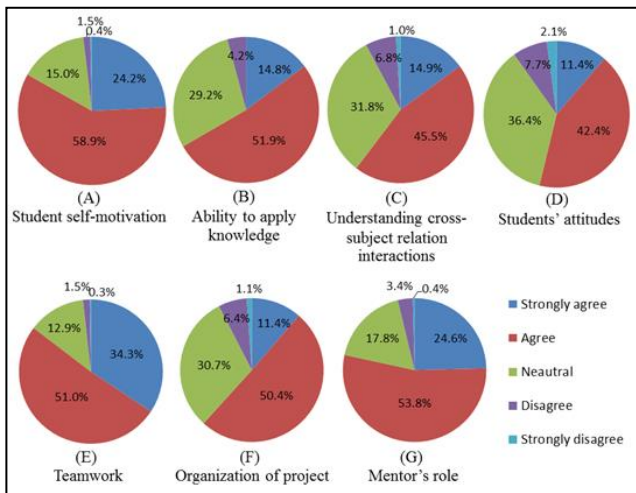


Fig. 6. The student's satisfaction of project-based learning.

Meanwhile, a significant negative opinion in students' attitudes was observed from student response, approximately 9.8% (Fig. 6D). This may be due to students might have to work more, spent extra time for self-study and hard to manage team work. These reasons correspond to the previous results which were shown that the project motivates more student self-study and teamwork. The understanding cross-subject relation is another negative opinion that the student provided feedback on neutral response (Fig. 6C). This may be due to the confusion of student about Mathematics/Physics content concepts and project may not drive students' understanding content concepts more than in their classroom.

### V. CONCLUSION AND SUGGESTIONS

The present research has explored the study results of the project-based learning based on integrated knowledge both physics and mathematics. In the previous section, the majority of students could understand and explain fundamental knowledge and the application of the quality of sound both in engineering and mathematics fields. Most students presented their project accurately and intelligibly. In terms of students' satisfaction, it is found that the majority of students were satisfied with the integrated project as it was reflected from students' learning attitude in seven categories: self-motivation, ability to apply knowledge, understanding cross-subject relation, students' attitudes, teamwork, an organization of

project and mentor's role. Also, it was found that students self-motivation and teamwork skill was promoted the most in comparison to the remaining five skills. According to student response, there was 9.8% of negative attitudes towards the integrated project. However, there were both positive and negative attitudes found in the response, which were concordant. That is to say, both sides of attitudes are likely to be the cause and effect of each other.

As integrated project learning was one of the contributions of KMUTT, Ratchaburi, physics and mathematics modules have collaborated for the first time. Therefore, there may have some areas that should be improved which are: 1) student achievement assessment; the 5-point Likert scale should be clearly defined. 2) questions in satisfaction questionnaire; the questions should be designed carefully regarding causes and real factors. So, it will be able to be used as the tool for improving students' project and 3) indicators; after finishing the project, the measurable indicators should be designed in order to measure students' qualifications.

### ACKNOWLEDGMENT

We would like to thank all teaching team both physics and mathematics for their data support. We also would like to thank Prof. B. Sirinaovakul for many useful discussions.

### REFERENCES

- [1] A. J. Rotherham and D. T. Willingham, "21st-Century skills," *American Educator*, vol. 17, 2010, pp. 17-20.
- [2] S. Bell, "Project-based learning for the 21st century: Skills for the future," *The Clearing House*, vol. 83(2), 2010, pp. 39-43.
- [3] P. Narjaikaw, N. Emarat, and B. Cowie, "The effect of guided note taking during lectures on Thai university students' understanding of electromagnetism," *Res. Sci. Technol. Educ.*, vol. 27, 2009, pp. 75-94.
- [4] E. J. Mills and D. F. Treagust, "Engineering education—Is problem-based or project-based learning the answer," *Australasian journal of engineering education* vol. 3(2), 2003, pp. 2-16.
- [5] P. C. Blumenfeld, E. Soloway, R. W. Marx., J. S. Krajcik, M. Guzdial and A. Palincsar, "Motivating project-based learning: Sustaining the doing, supporting the learning," *Educational psychologist*, vol. 26(3-4), 1991, pp. 369-398.
- [6] J. S. Krajcik and P. C. Blumenfeld, "Project-based learning," *The Cambridge handbook of the learning sciences* In R. K. Sawyer (Ed.), New York: Cambridge, 2006, pp. 317-334.
- [7] Y. Gülbahar and H. Tinmaz, "Implementing project-based learning and e-portfolio assessment in an undergraduate course," *Journal of Research on Technology in Education*, 2006, vol. 38(3), pp. 309-327.



# Learning Development By Using Peer Assisted Learning: A Case of Residential College

**Nuttapong Prasertsung, Mai Noipitak**

Ratchaburi Learning Park  
King Mongkut's University of Technology Thonburi  
Ratchaburi, Thailand  
nuttapong.pra@mail.kmutt.ac.th, mai.noi@kmutt.ac.th

**Sukanlaya Tantiwisawaruj**

Learning Institute  
King Mongkut's University of Technology Thonburi  
Bangkok, Thailand  
sukanlaya.tan@kmutt.ac.th

**Abstract**— The purposes of this research were to 1) develop students' learning 2) to evaluate the achievement of students in professional skill 3) to evaluate students' attitudes towards peer assisted learning: A Case of Residential College. The research tools consisted of 1) peer assisted learning, 2) welding practice model, 3) the questionnaire to evaluate students' attitudes towards peer to assisted learning: A Case of Residential College. The sample group in this research was sixty-one undergraduate students from faculty of engineering, King Mongkut's University of Technology Thonburi, Ratchaburi. The data were analyzed by using mean, standard deviation and paired sample t-test. The results of research were as follows: 1) the achievement of students in professional skill was higher with statistical significant at the 0.05 level. 2) The attitudes of students toward peer assisted learning was at the highest level. (Mean = 4.59, S.D = 0.62)

**Keywords**— *development, peer assisted learning, residential college*

## I. INTRODUCTION

Nowadays, the world is changing rapidly in many terms such as politics, society, economic, communication and technology and affects direct and indirect in our daily life. It leads to the increasing of competition in a world-wide scale. So we should develop potential of domestic population in order that nation can keep up the world changing. Education is the beginning to develop people for quality. In the present, thinking and innovation must have people in center of production. So potential increasing of people is necessary for sustain economic and social development [1]. 21st century is transforming age from conventional economic cultural and sufficient society that leads into information society knowledge-based economy and cross culture [2]. It has brought in different frontiers of constraints and challenges for higher education. In today's rapidly changing market, employers are already focusing on the importance of what graduates will be able to do on the job. With many 21st century skills (such as complex/creative problem solving, multi-disciplinary knowledge application, life-long learning and adaptability) on the top of their lists, it is essential that universities provide opportunities for higher-order thinking skill development, as well as for knowledge integration

across content areas. Fast growing changes in the global landscape and the technology revolution drives the demand for high quality, engaging and seamless experiences both for online and face-to-face learning. Abstracted virtual learning and a variety of personalised, mobile and adaptive technologies are emerging to provide instant access to the learning environment where students can socially engage and interact with teachers and peers when and where they need it. This requires new ideas on pedagogical methods, technologies and facilities that can readily adapt to individual learning preferences [3].

According to the 11th national economic and social development plan (2012-2016), curriculum development and learning-teaching process should be adjusted in order to facilitate learner's development. It has integrated variety of learning styles including academic, life skill and recreation that cover art, music, sport, culture, religion, democracy, Thai definition and ASEAN study. It focuses on learning from inside-outside classroom, a habit of learning suspense, thinking, analysis, problem-solving skill and open-minded. Student can on their thinking to create new innovation and arrange volunteer activities for public benefit [4].

King Mongkut's University of Technology Thonburi, Ratchaburi has instructed Residential College which focuses on the following concepts: 1) the learner can develop intellect and characteristic of good citizenship that leads to change agent in knowledge competencies, life and social skills. Learner can link and apply knowledge with other problems and disciplines. 2) College Life: residence will be divided into subgroup that consist of learners and teachers. It is called college. College has administration, management, care and doing activities together. Learning and college life in Residential College are important to develop personality of responsible citizen and build up leadership of learner [5].

The teaching process emphasizes the learning that is the goal of educational management. Learning means learner's behavior changing in three aspects: knowledge, skills and attitudes [6]. Learning is not only the knowledge that receives from parents, teachers or computer. But it happens from social interaction. Maybe learner can create it from discovery experimentation observation or instructors' support that reveals with competencies of learner [7]. So, learning management has many effective with learners' behavior that leads to 1) skill, the learner can do skill fully

and accuracy. 2) Attitude is feeling and reaction which maybe are positive or negative with something. It has an effect on learning. So, the learner has a positive attitude towards a subject. He is going to work harder in that course [8].

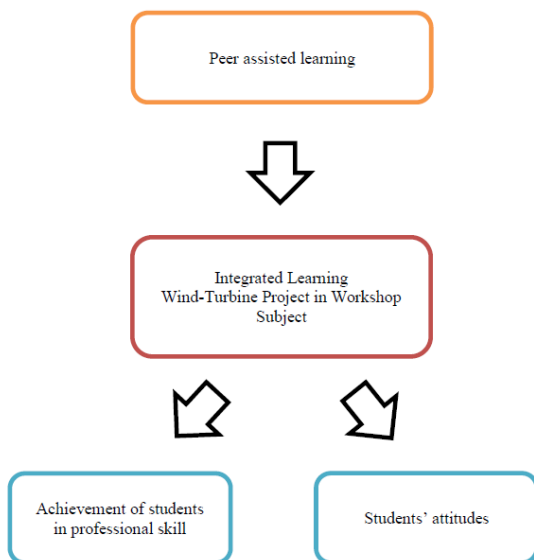
Peer assisted learning can be defined as people from similar social groupings, who are not professional teachers, helping each other to learn and learning themselves by teaching [9]. Proximity of peer teachers and learner is more likely to understand aspects of a topic learners may find conceptually difficult and to explain it in ways that are easily understood. The social proximity of peer teacher and learner is thought to allow students to express difficulties more comfortably, to feel relaxed and build confidence through observation of a peer in a teaching role. Development of organisational skills, communication and presentation skills [10].

According to national education policy and learning development, the researcher appreciates learning development of learners that can help the learner to open-mind, learn from environment and have positive attitudes in work and study. This research aims to develop students learning, evaluate the achievement of students in professional skill and evaluate students' attitudes towards peer assisted learning: A case of Residential College.

## II. PURPOSES

- To develop students learning by using peer assisted learning.
- To evaluate the achievement of students in professional skill by using peer assisted learning.
- To students' attitudes towards peer assisted learning.
- 

## III. CONCEPTUAL FRAMEWORK



The conceptual framework of Learning Development Using Peer Assisted Learning: A Case of Residential College.

## IV. HYPOTHESIS

- A. *The achievement of students in professional skill is higher with statistical significant at the 0.05 level. After studied peer assisted learning.*
- B. *The attitudes of students toward peer to assisted learning is at a high level.*

## V. METHODOLOGY

### ○ Population and sample

The sample used in this research was sixty-one undergraduate students from faculty of engineering, King Mongkut's University of Technology Thonburi, Ratchaburi. They were selected by purposive sampling.

### ○ Context

Context of this research was knowledge and skills in welding operation.

### ○ Variable

The variables used in this research were Independent variable was peer assisted learning.

Dependent variables were the achievement of students in professional skill and students' attitudes towards peer assisted learning.

### ○ Tool

The tools of this research consisted of

- Peer assisted learning.
- welding practice model.
- The questionnaire to evaluate students' attitudes towards peer assisted learning.

### ○ Data collection and analysis

- Orientation to introduce and explain about details and activities in this course.
- Sample group was divided into sub groups. The sub groups studied in welding topic and did pre-test by using welding practice model.
- Then sample group studied in welding topic again by using peer assisted learning that students who had low professional skill were taught by high professional skill students on their satisfactions.
- Finally, sample group did post-test by using welding practice model and assessed students' attitudes towards peer assisted learning.

### ○ Statistic

Used paired sample T-Test to compare the achievement of students in professional skill [11].

Used mean and standard deviation to evaluate the attitudes of students towards peer assisted learning.



VI. RESULTS

The result of achievement of students in professional skill are shown the following table I.

THE ACHIEVEMENT OF STUDENTS IN PROFESSIONAL SKILL BY USING PEER ASSISTED LEARNING

N	Test	Statistics			S.D. <sub>D</sub>	T
		Mean	S.D.	$\bar{D}$		
50	Pre	7.44	0.64	0.51	0.85	4.25
	Post	7.95	0.64			

Fig. 2. Used paired sample T-Test to compare the achievement of students in professional skill.

Table I shows the result of the achievement of students in professional skill by using peer assisted learning. The number of students was 50. The mean of pre-test was 7.44 and post-test was 7.95. After analysis by using paired sample t-test found the achievement of students in professional skill was higher with statistical significant at the 0.05 level.

THE RESULT OF STUDENTS' ATTITUDES TOWARDS PEER ASSISTED LEARNING

Items	Statistic		
	Mean	S.D.	Level
<b>1. Emotion and intellect</b>			
1.1 Peer assisted learning can help to reduce anxiety in working.	4.55	0.66	highest
1.2 Peer assisted learning can help to relax in working.	4.73	0.52	highest
1.3 Peer assisted learning can help to understand easier.	4.70	0.52	highest
1.4 Peer assisted learning gives new perspectives, methods, skills and experiences in working.	4.34	0.78	high
1.5 Peer assisted learning can help to plan next working.	4.36	0.66	high
<b>Average</b>	<b>4.53</b>	<b>0.63</b>	<b>highest</b>
<b>2. Social and adaptive</b>			
2.1 Peer assisted learning helps students to adapt with others.	4.62	0.64	highest
2.2 Peer assisted learning increases interaction between students.	4.63	0.58	highest
2.3 Peer assisted learning helps students to shows theirs kindness and helps others.	4.73	0.57	highest
2.4 Peer assisted learning helps students dare to give one's opinion and ask questions.	4.58	0.63	highest
2.5 Peer assisted learning helps to fullfill individual differences.	4.58	0.59	highest
<b>Average</b>	<b>4.63</b>	<b>0.60</b>	<b>highest</b>
<b>Total average</b>	<b>4.58</b>	<b>0.62</b>	<b>highest</b>

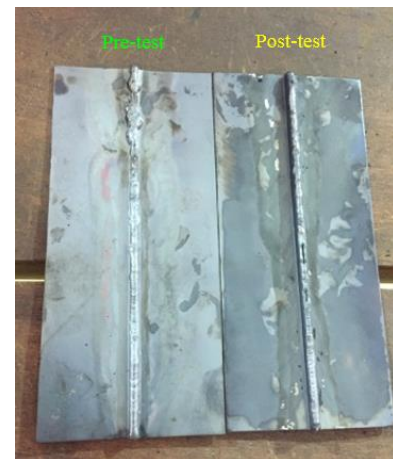
Fig. 3. Mean and standard deviation (S.D.) of students' attitudes towards peer assisted learning.

From table II shows the result of students' attitudes towards peer assisted learning that found students' attitudes were in highest level (total average = 4.58, S.D. = 0.62).

Emotional and intellectual was in highest level (average = 4.53, S.D. = 0.63). Social and adaptive was in highest level (average = 4.63, S.D. = 0.60).



Environment of peer assisted learning that the low professional skill was taught by the high professional skill on his/her satisfactions.



The achievement of student in professional skill studied by peer assisted learning.

VII. DISCUSSION

This research is Learning Development by Using Peer Assisted Learning: A Case of Residential College. When sample group did pre-test in welding practice model. The eleven students had high professional skill and fifty students had low professional skill. Afterwards, they learned by using peer assisted learning and did post-test that found: 1) the achievement of students in professional skill was higher with statistical significant at the 0.05 level. This shows peer assisted learning that helped students to understand easier and act advance further in welding operation. It stimulated and encouraged interaction within students' group and included classroom environment that helped students to develop themselves, open theirs mind and learn better from environment. Teaching technique was appropriately designed for context, age and level of students. The result is

consistent with Evaluation of the efficacy of peer-learning method in nutrition students of Shiraz University of Medical Sciences [12]. It indicates the level of knowledge of students, who participated in this course, has significant difference before and after the peer learning course (pair t-test=1.010, p=0.002). Moreover, it is consistent with Development of Cooperative Learning Methodology of Peer Assisted Learning for Students of Sukhothai Thammathirat Open University: Case Study of Thai Studies Course Samutsakorn Province [13]. The result of the study indicates the learning achievement of experiment group taken before and after cooperative learning method have positive relationship at moderate level with statistical significance at the level of 0.01. 2) The attitudes of students towards peer assisted learning was at the highest level due to learning environment encouraged interaction between students. It increased and enhanced opportunities in learning that consisted of: 2.1) emotion and intellect, peer assisted learning can help students to reduce anxiety, create new approaches in working and understand easier because the environment in classroom and language was friendly. 2.2) Social and adaptation, peer assisted learning can help students to adapt and show their kindness with others, give one's opinion and ask question when they wonder. Moreover, peer assisted learning can help to fulfill individual differences. This result is consistent with Chusri Suwan [14] who studied in Learning Activities by Using Peer Assisted Learning and Relaxation Training on Stress Reduction of Student in Faculty of Education, Chiang Rai Rajabhat University that found students' stress after the experiment were lower than the ones before participated in learning activities and the students' satisfaction in Peer Assisted Learning was at the high level.

#### ACKNOWLEDGMENT

We would like to thank our colleges to allow and support for this research. Lecturers of workshop module for their data support and many suggestion.

#### REFERENCES

- [1] K. Mingsiritham, "Creative educational media design," Chulalongkorn University Press, 2016, pp 1.
- [2] T. Laohajaratsang, "21<sup>st</sup> Century Skills for CMU Faculty Development," 2014, [Online]. Available: <https://www.pharmacy.cmu.ac.th>. [Accessed: Apr. 2, 2018].
- [3] K. S.Tawornpichayachai., "KMUTT 3.0 -Because great things take time," 2016, pp 3. [Online]. Available: <http://www.mua.go.th>. [Accessed: Jan. 4, 2016].
- [4] National Economic and Social Development Board Office of the Prime Minister, "THE ELEVENTH NATIONAL ECONOMIC AND SOCIAL DEVELOPMENT PLAN (2012-2016)," Bangkok: National Economic and Social Development Board Office of the Prime Minister, 2012, pp. 46. [Online]. Available: <http://www.nesdb.go.th>. [Accessed: Jan. 4, 2018].
- [5] King Mongkut's University of Technology Thonburi, "New engineering teaching approaches management at King Mongkut's University of Technology Thonburi (Ratchaburi) Residential of the west," 2012. [Online]. Available: <http://www.eng.kmutt.ac.th>. [Accessed: Dec. 3, 2017].
- [6] S. Sikkhabandit, "Meaningful for learning," 2<sup>nd</sup> ed., Thai Wattana Panit Publishing, 1989, pp 81.
- [7] M. Zhou & D. Brown, "Educational Learning Theories, GALILEO University System of Georgia," 2015, pp. 31. [Online]. Available: <https://oer.galileo.usg.edu>. [Accessed: Jan. 20, 2018].
- [8] VALAYA ALONGKORN RAJABHAT UNIVERSITY UNDER THE ROYAL PATRONAGE SAKAEO, "Handbook for management of student-centered teaching and learning system," Tienwattana Printing, 2010, pp. 51-55. [Online]. Available: <http://acad.vru.ac.th>. [Accessed: Jan. 22, 2018].
- [9] K.J. Topping, "The Effectiveness of peer tutoring in further and higher education: A typology and review of the literature," Kluwer Academic Publishers, vol. 32, no. 3, 1996, pp. 322. [Online serial]. Available: <https://link.springer.com/article/10.1007/BF00138870>. [Accessed: Apr. 3, 2018].
- [10] E. Hill, F. Liuzzi, J. Giles, "Peer-assisted learning from three perspectives: Student, tutor and co-ordinator. The Clinical Teacher," vol.7, no. 4, 2010, pp. 244-246. [Online serial]. Available From URL <http://dx.doi.org/10.1111/j.1743-498X.2010.00399.x>. [Accessed: Apr. 3, 2018].
- [11] B. Kijpredarborisuthi, "Social sciences research methodology," 9<sup>th</sup> ed., Bangkok: Chamchuree Products CO.,LTD, 2006, pp 381.
- [12] M. DEGHANI, M. AMINI, J. KOJURI, and P. NABEIEI, "Evaluation of the efficacy of peer-learning method in nutrition students of Shiraz University of Medical Sciences," Journal of Advances in Medical Education & Professionalism, vol. 2, no. 2; April, 2014. [Online]. Available: <https://www.ncbi.nlm.nih.gov/pmc/articles/PMC4235552/>. [Accessed: Feb. 12, 2018].
- [13] T. Mosikarat, S. Sripunworasakul, N. Malai, S. Lueangsuwan, C. Wattanasiri and A. Cittaladakorn, "Development of Cooperative Learning Methodology of Peer Assisted Learning for Students of Sukhothai Thammathirat Open University: Case Study of Thai Studies Course Samutsakorn Province," Sukhothai Thammathirat Open University Journal, vol. 21, no. 1, 2008, pp 106-118.
- [14] C. Suwan, "Learning Activities by Using Peer Assisted Learning and Relaxation Training on Stress Reduction of Student in Faculty of Education, Chiang Rai Rajabhat University," 2017. [Online]. Available: <https://slidex.tips/download/24>

# Emotional Analysis of Elementary Students with and without Learning Inefficiency Using an Emotion Detecting Application

**Rodel D. Estamo**

Department of Computer Science  
Cebu Institute of Technology –  
University  
Argao, Cebu  
rdestamo@gmail.com

**Ephraime Xezpyr L.**

**Godinez**

Department of Computer Science  
Cebu Institute of Technology –  
University  
Lapu-Lapu City, Cebu  
cs.exlgodinez@gmail.com

**Patrick Andrew Pelias**

Department of Computer Science  
Cebu Institute of Technology –  
University  
Guindulman, Bohol  
papelias1337@gmail.com

**Fritz Laurence R. Villacorta**

Department of Computer Science  
Cebu Institute of Technology – University  
Dalaguete, Cebu  
fritzvillacorta@gmail.com

**Ralph P. Laviste**

Department of Computer Science  
Cebu Institute of Technology – University  
Cebu City, Cebu  
rlaviste@gmail.com

**Abstract— Studying the differences of emotions between students with and without learning inefficiency is important in establishing teaching styles, methods and pacing intentionally designed for the student. Using an emotion detecting application, the emotions of 48 grade school students were collected during the course of a video learning material. Students with learning inefficiency tend to have higher confusion. Students with no learning inefficiency tend to exhibit (a.) higher attention towards the video and (b.) higher negative valence. The video used with the title of “How to Treat a Cut: Knife Wound First Aid” generated 34% more negative reactions than there are positive ones. This can further be supported by low engagement scores. Based on sex, females show higher attention and engagement but males have higher positive valence than females. Based on grade level, the Grade 6 group have the least confusion and highest attention than other grade levels. However, the Grade 3 students exhibited the least engagement and highest negative valence. Three-way MANOVA did not successfully reveal any significant correlation of the presence of learning inefficiency with other controlled factors such as sex and age.**

**Keywords— emotion, learning disability, EDEN, e-learning, engagement, attention, valence, confusion**

## I. INTRODUCTION

### A. Background of the Study

Emotions are expressed through speech, actions and facial expressions. Observing what a person is trying to

convey through their words and movements helps in understanding what that person is currently experiencing and can give a clue on their behavior towards different circumstances. As individuals interact with the community, they observe emotions being expressed by others verbally and non-verbally, and those individuals who respond and act appropriately to these cues tend to be more favored in society than those who do not. Similarly, children who are incapable of understanding their social environment are found to have some form of learning disability, which may be verbal or nonverbal. Children with nonverbal learning disabilities find it difficult to understand emotions expressed by facial expressions and consequently lead to strained social interactions with their parents, teachers, peers and even strangers alike.

In the Philippines, the term e-learning is used synonymously with online learning and concerns the online delivery of instructional content as well as associated support services to students [4]. E-learning is most effective when five dimensions, namely, (1) learner attitude, (2) instructor quality, (3) system quality, (4) information or content quality and (5) service are well managed and executed [5]. Online video tutorials and webinars are among the resources that can be found and easily accessible through electronic devices such as smartphones and tablets. Audio-visual means of acquiring new skills are often preferred over spending countless hours poring over paragraph after paragraphs of text in print and digital mediums as there is an increasingly large amount of unfiltered information that may be acquired online, and even so, confirming each information's validity is time

consuming in itself. Even news reporting has evolved from in-depth reporting to real-time tweeting and single line scrolls on television screens to clickbait [6]. Clickbait articles and videos are gaining popularity as of late and there is a reason for its stay. In Loewenstein's information gap theory of curiosity, he stated that "people feel a gap between what they know and what they want to know." Curiosity and emotion play a factor in the virality of these types of content.

Compelling content that make people emotionally engaged are more often remembered than not. In an emotional Stroop test conducted by MacKay and his team, participants were presented with different words in quick succession. Each word was printed in a different color, and subjects were asked to name the color. They were also later asked to recall the words after the initial test. They found that taboo words, which were intended to elicit an emotional response, were recalled more frequently than words which carried less emotional connotations [7]. The present study is conducted to test how a student's emotional response to a video learning material affect learning and to compare the gathered data between students with and without learning disabilities.

### B. Objective of the Study

In response to the progress of e-learning in the Philippines, this study is aimed to identify and classify emotions present and absent between elementary students during the course of a video learning material. This study also specifically wants to:

- Recognize the differences in results between students with and without learning inefficiencies;
- Ascertain the effectiveness of the chosen video learning material based on the general reaction detected from the student subjects;
- Determine the differences in accumulated emotion data based on grade level and sex of the student subjects.

## II. REVIEW OF RELATED LITERATURE

### o E-Learning

E-Learning can be defined as the "the delivery of content via all electronic media, including the internet, intranets, extranets, satellite broadcast, audio/ video tape, interactive TV, and CD-ROM" [8]. The mentioned definition focuses on how information is delivered. It can also be defined as a way of acquiring knowledge thru electronic means [9]. In a broad sense, e-learning is any learning that is obtained electronically [10]. However, this definition has narrowed down to any kind of learning available in the Internet, and viewed in the web [11].

The availability of a wide range of information of Internet is a huge advantage to be efficient in obtaining knowledge. E-learning is cost effective since there is no need to travel, and thus, there is lesser time spent. Barriers

that hinder participation is also eliminated through discussion forums which are found in an online resource. Interaction between learners and teachers happen in the forums, and there is no need to talk to others in a physical setting. Disadvantages include negative impact of communication skills due to isolation, and the possibility of cheating due to dependency on forums [12].

### o Multimedia in E-learning

Use of graphics and words, such as spoken words and static images, animations and video presentations are encouraged in e-learning resources. A learner is more likely to understand a multimedia material only when he/she is attentive to the lessons presented, mentally organizing the material into a logical cognitive representation, and mentally integrating the retrieved knowledge to his/her existing knowledge. By the presented words and pictures, a learner is encouraged to engage in learning by making connections between them [13].

Learning materials presented in video formats grab a learner's attention and motivates them to learn. The material's primary aim for effective learning is to stimulate the interest of a learning, to keep him/her engaged to the subject at hand [14]. Videos also help in providing learners and exposing them with a closest depiction of reality which they don't have an opportunity to see, such as witnessing war from a documentary, or observing a surgery operation, thus, learners are more likely to have a mental picture of what they learned from the video, as opposed to text-based learning [15].

### o Emotions and its Connection to Learning

Emotion can be portrayed by the people through different channels like body movements, physiological reactions and facial expressions. These channels can be a source of information which allows computer to detect and recognize affect. Tracking down this information can be used then to offers an adaptive learning flow and evaluate learner's state of learning [16].

The impact of emotion to learning processes is one of the subjects in a research nowadays. It is said in some studies that positive emotion improves learning and contributed to academic achievement, being mediated by the levels of self-motivation and satisfaction materials [17] and a negative learning-centered state improves learning in a sense that it increases focus of attention on learning materials that leads to higher performance [18]. It is then proved that emotion is an essential tool in learning process of students at present.

### o Related Studies

Emotion plays a vital role in analyzing students' interest in a learning environment [19]. We can see either the positive or the negative affect to the students while undergoing in a learning process through their emotions.

Out of many various ways to detect an emotion, understanding it through facial expression is a quick process of gathering information. Methods like face identification,



measurement of optical flow and pose recovery [16] is the one who turns a students' emotion into an informative data that can be used to analyze the overall reaction using an E-Learning material.

The emotions being gathered may differ from one student to another and with this, we can classify people in terms of their learning capabilities. One of these is that classifying students having or not having a learning inefficiency. A study revealed students with learning inefficiencies to be less accurate interpreter of emotion and spend more time identifying specific emotion [20].

### III. METHODOLOGY

#### o Research Design

The student samples were chosen with the following variables: Year level, sex, and presence of learning inefficiencies. Given the 48- student sample size, it was assured that at least two to three (2-3) students represented one set. The top students per year level per gender represents the students without learning inefficiency while the lowest-performing students per year level per gender represents the students with learning inefficiency. Rankings are based on grade point average.

Phone models used in playing the video learning material were of the same camera pixel densities and running EDEN, the dedicated emotion detecting platform used to recognize emotions while users are watching a video material.

#### o EDEN

EDEN, or the Emotion Detecting E-Learning Network, is a mobile application developed by the researchers and was used as the main tool in recognizing the emotions portrayed by the student subjects whilst watching the video learning material. It runs on Android version level 21 and above and requires camera pixels not less than 8 pixels.

It allows users to choose a video available on YouTube and play it inside the app. While the video is playing, the front-facing camera captures the emotions of the user watching a video in real time, recording it until the very last second of the video. It uses an emotion-detecting API from Affectiva.

The application outputs the number of seconds an emotion has been exhibited throughout the duration of the video material. While running EDEN, it checks the number of seconds of 4 facial patterns namely: Engagement, Attention, Confusion and Valence. With these facial patterns, EDEN can conclude a particular emotion that is dominant on the user's face at during the course of one video learning material

#### o Identification and Classification of Emotions Detected

The mobile phones running EDEN loaded with the video learning material were placed at an arm's length from the student's face.



Fig. 1. Student is watching the video learning material.

As the video material finishes, the students were then removed from the testing area and the recorded data is automatically stored to Firebase Realtime Database on which the structure of the database is as follows:

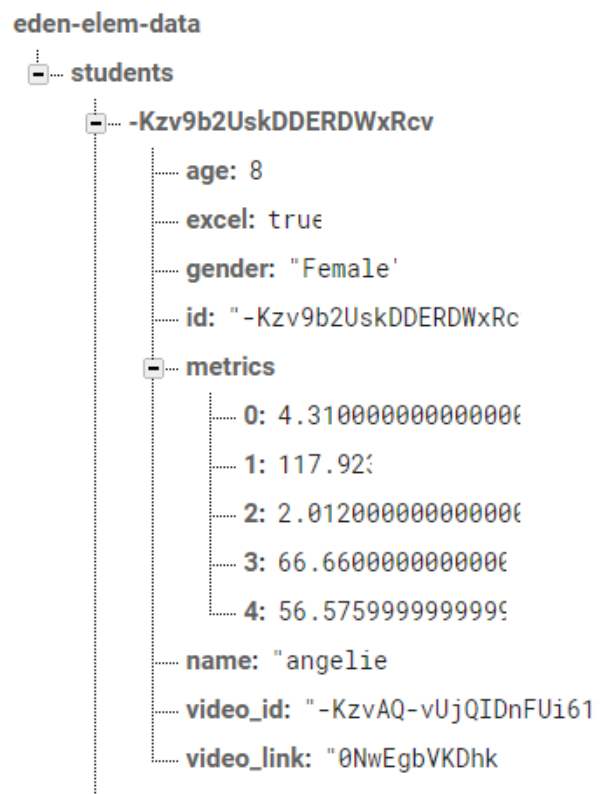


Fig.2. EDEN's Firebase Realtime Database internal structure

Under the metrics child, the numbers 0 - 4 corresponds to the total number of seconds for Confusion, Attention, Engagement, Positive Valence and Negative Valence respectively.

o *Determining the Effectivity of the Video Learning Material*

Using the Valence data gathered, the researchers calculated the effectivity of the chosen video by using the following formula:

$$\text{Effectivity} = \frac{\text{positive valence} - \text{negative valence}}{\text{total seconds in the video}}$$

**Fig.3.** Effectivity formula based on valence

wherein if the value of effectivity is positive, it denotes a better appreciation of the video material as regards to the user watching it. The closer it is to 1, the better its effectivity. Consequently, if the value of effectivity is negative, it denotes a unsatisfactory appreciation of the video material. The closer it is to -1, the worse the effectivity of the video is to the student watching it. Finally, if the effectivity has a value of zero (0), the appreciation of the video learning material is neutral.

o *Recognizing the Differences of Results Regarding Learning Disabilities*

As explained in section 3.1, learning disabilities is characterized as a condition giving rise to difficulties in learning specific skill sets to the level that is expected from those with the same age, more so if not associated with any physical handicap.

In determining the differences of the results from both students with learning disability and to those who are without learning disability, the average number of seconds from the Confusion, Engagement, Positive and Negative Valence and Attention values detected from each student were compared.

o *Determining the Differences in Data Based on Grade Level and Sex*

In determining the differences in emotion data based on Grade Level, the average seconds of Confusion, Engagement, Positive Valence, Negative Valence and Attention were compared between all four grade levels.

In continuation, finding out the differences of emotion data based on sex, the entirety of the student sample was divided into two: male and female. After which, the average seconds of Confusion, Engagement, Positive Valence, Negative Valence and Attention will be compared also between the two sides.

o *Multivariate Analysis of Variance (MANOVA)*

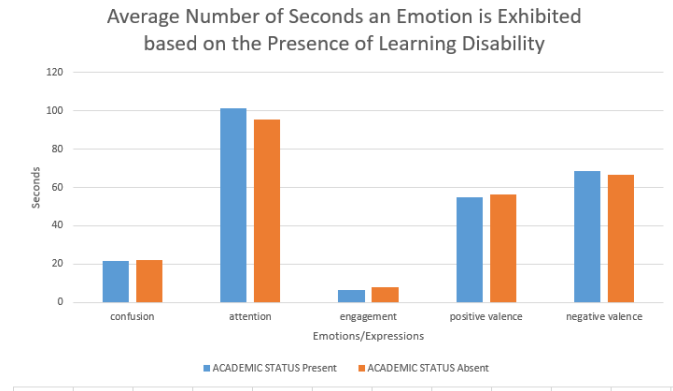
A three-way multivariate analysis of variance was conducted to determine the effect of a student’s age, gender, and his/her academic standing to each of the five (5) emotions that are being monitored while watching the video learning material.

This was also done in order to notice correlations and trends between student’s age and gender with the presence or absence of learning disability solely based on the emotion data collected.

IV. RESULTS AND DISCUSSION

o *Differences Between Students With and Without Learning Disabilities*

After analyzing the emotion results between the accumulated results of students with learning disabilities and from students without learning disabilities, it can immediately be noticed that there are no wide differences between confusion, engagement and both Valences.



**Fig.4.** Average Number of Seconds an Emotion is Exhibited based on Academic Status

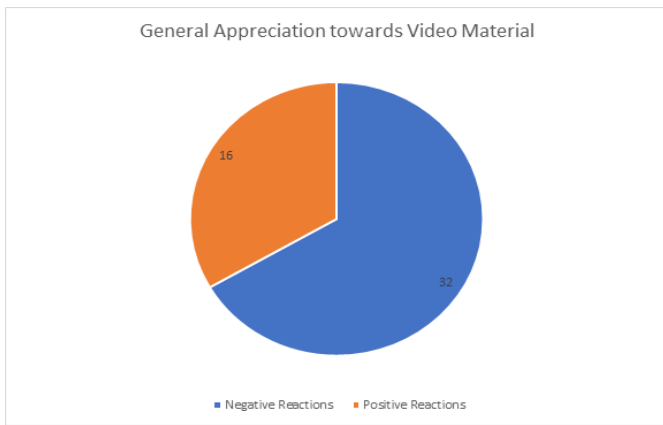
However, there is a 5.48-second gap in the Attention value on which students with no learning disabilities have a higher attention score than those who have learning disabilities. Also, students with learning disabilities have higher confusion score with a .42-second more than their counterpart.

On the other hand, students without learning disabilities seems to have a negative outlook towards the video and lesser engagement with a 1.40-second difference connoting boredom or disinterest towards this specific video.

o *Effectivity of the Video Learning Material Based on General Appreciation*

Using the formula stated on Section D of the Methodology, all 48 student subjects have been divided into two classification: one, whose general appreciation towards the video learning material is positive and second, whose general appreciation towards the same video learning material is negative.





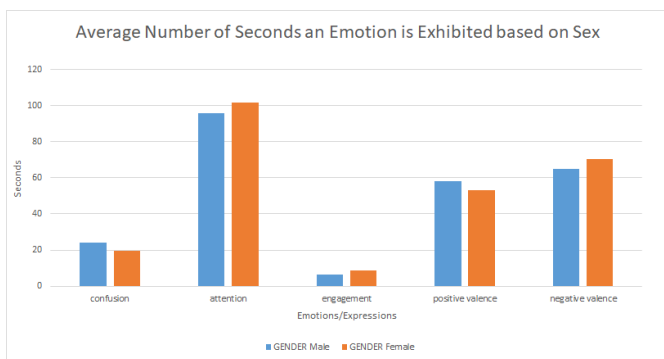
**Fig.5.** General Appreciation towards Video Material

As shown in the graph above, it can be concluded that the chosen video learning material for the study generated 34% more negative reactions than there are positive ones. This can further be supported by the low engagement scores.

In order for a reaction to be considered positive, the number of seconds of the positive valence from a particular student must be above 50% of the total number of seconds of the given video. Anything lower connotes disinterest or bad reaction towards the video material. In this study, the chosen video material is a video tutorial for applying first-aid to open wounds. The URL of the video is as follows: [www.youtube.com/watch?v=0NwEgbVKDhk](http://www.youtube.com/watch?v=0NwEgbVKDhk)

o Differences on Emotional Data Based on Sex

For this test, the average scores between male and female is being used. After plotting the scores from both sexes, there are clear gaps between the scores although, not by long.

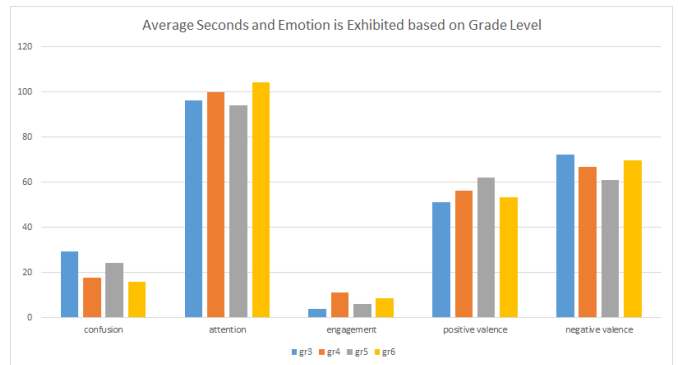


**Fig.6.** Average Number of Seconds an Emotion is Exhibited based on Sex

The confusion is evidently low for the females together with a higher score for attention with a 5.87-second gap and engagement with a 2.24-second gap. This suggests that females are generally more interested towards the video material than the male counterpart. However, the males have higher valence than the females which suggests that although females are more interested, the contents of the video material is uncomfortable for them.

o Differences on Emotional Data Based on Grade Level

The chosen year levels from the elementary department are as follows: Grades 3, 4, 5 and 6. Although all year levels are familiar with the topic covered inside the video learning material, There are very noticeable differences in all of the emotions covered in this study.



**Fig.7.** Average Seconds and Emotion is Exhibited based on Grade Level

For the confusion score, it is evident that the lowest of the grade levels would have the highest confusion score, with the grade 6 group obtaining the lowest confusion score with only 15.75 average seconds of recorded confusion. All grade levels have very high scores on the attention value with the grade 6 group as the highest with 104.18 seconds. Oppositely, the engagement values of all grade levels are very low with the 3rd graders as the lowest with only 3.88 seconds of recorded engagement on average. For the valence values, the 3rd graders received the most negative reactions while the 5th graders gained the highest number of positive reactions.

Given the data above it can be safely concluded that 3rd graders are not yet well-versed with the topic contained in the video learning material although, they are familiar with it. 6th graders and 5th graders however, shows easy understandings with the topics at hand.

o Analysis of three-way MANOVA

Effect		Value	F	Hypothesis df	Error df	Sig
grade * excel	Pillai's Trace	.357	.809	15.000	90.000	.665
	Wilk's Lambda	.658	.848	15.000	77.697	.622
	Hotelling's Trace	.498	.886	15.000	80.000	.582
	Roy's Largest Root	.451	2.705	5.000	30.000	.039

**Fig.8.** Result for the correlation of Grade Levels and Learning Disability

A statistically significant interaction between the presence of a student's learning disability and grade level was found in Roy's Largest Root of  $p = 0.039$ ,  $F(5, 30) = 2.71$ . With a threshold of 0.05, this significant value connotes that learning disability would be become less or more evident as the grade level of a student progresses.

However, the results of Pillai's Trace, Wilk's Lambda and Hotelling's Trace were not found significant to completely support this claim, rendering this founding null. Also, all of the other multivariate test results are insignificant, with the p-value hovering above 0.05. Further tests were not conducted due to the insignificant findings.

## V. CONCLUSIONS AND RECOMMENDATIONS

### o Conclusions

Students with learning disabilities tend to have higher confusion than students with no learning disabilities. Students with no learning disabilities tend to exhibit more attention towards the video learning material. Also, students with no learning disabilities show negative outlook towards the video connoting boredom or disinterest.

Based on the Valence values of all students under the study, the specific video with the URL [www.youtube.com/watch?v=0NwEgbVKDhk](http://www.youtube.com/watch?v=0NwEgbVKDhk), generated 34% more negative reactions than there are positive ones. This can further be supported by the seemingly low engagement scores.

Analyzing the data based on sex, females show higher attention and engagement which suggest that females are more interested than males but males have higher positive valence than females which suggests that although females are more interested, the contents of the video material is uncomfortable for them.

Analyzing the data based on grade level, the Grade 6 group shows the least confusion and the highest attention than other grade levels. On the other hand, the Grade 3 students showed the least engagement and highest negative valence which could suggest that 3rd graders are not yet well-versed with the topic contained in the video learning material or they are still uncomfortable with it.

Finally, there were no statistically significant correlations found as regards to the presence of learning disability with other controlled factors such as age group and sex. This is based on the multivariate statistical tests performed.

### o Recommendations

The researchers recommend that possible new researches in this field may be done with bigger sample size, and in a larger scope in terms of diversity of ethnicity, race, age, and gender. This is to ensure more accurate and more varied set of data that can aid the E-Learning community

thrive better. Variations in video material (e.g., the content, video length) should also be considered.

The raw data collected is the amount of time an emotion is conveyed while watching an interactive learning material to fulfill the objective; thus, the researchers suggest that in order to determine the effectivity of the video in terms of its content, the trend of a corresponding emotion over the course of a video should be collected and analyzed.

Also, follow-up studies are recommended to be done frequently to track changes in behavior, trend and preferences of student subjects. The use of EDEN as a tool for emotion detecting is also encouraged in order to increase the accuracy and popularity of the said application.

## REFERENCES

- [1] M. M. Dela Pena-Bandalaria, "E-Learning in the Philippines: Trends, Directions, and Challenges," *International Journal on E-Learning*, vol. 8, no. 4, 2009.
- [2] S. Ozkan and R. Koseler, "Multi-dimensional students' evaluation of e-learning systems in the higher education context: An empirical investigation," *Computers & Education*, vol. 53, no. 4, pp. 1285-1296, 2009.
- [3] Panneerselvan, A. (2018). Our attention spans are not shrinking. [online] *The Hindu*. Available at: <https://www.thehindu.com/todays-paper/tp-opinion/our-attention-spans-are-not-shrinking/article22653031.ece>
- [4] D. G. Mackay, M. Shafto, J. K. Taylor, D. E. Marian, L. Abrams and J. R. Dyer, "Relations between emotion, memory, and attention: Evidence from taboo Stroop, lexical decision, and immediate memory tasks," *Memory & Cognition*. vol. 32, no. 3, 2004.
- [5] T. A. Urdan and C. C. Weggen, "Corporate e-learning: exploring a new frontier," *WR Hambrech CO*, 2000.
- [6] E. Meyen, et. al., "E-learning: a programmatic research construct for the future," *Journal of Special Education Technology*, vol. 17, no. 3, 2002.
- [7] M. M. Abbad, D. Morris and C. de Nahlik, "Looking under the bonnet : factors affecting student adoption of e-learning systems in Jordan," *International Review of Research in Open and Distance Learning*, vol. 10, no. 2, 2009.
- [8] C. Keller and L. Cernerud, "Students' perception of e-learning in university education," *Learning, Media and Technology*, vol. 27, no. 1, pp. 55-67, 2002.
- [9] A. A. Y. Al-Qahtani and S. E. Higgins, "Effects of traditional, blended and e-learning on students' achievement in higher education," *Journal of computer assisted learning.*, vol. 29, no. 3, pp. 220-234, 2013.
- [10] R. C. Clark and R. E. Mayer, "E-Learning and the science of instruction: proven guidelines for consumers and designers of multimedia learning," New York, NY: John Wiley et Sons, 2016.
- [11] L. Oishi, "Did You Just See that? Online Video Sites Can Jumpstart Lessons," *Technology & Learning*, vol. 27, no. 6, pp. 32, 2007.
- [12] D. DeLeng, D. Dolmans and M. van de Wiel, "How video cases should be used as authentic stimuli in problem-based medical education," *Medical Education.*, vol. 41, no. 2, pp. 181-188, 2007.
- [13] M. Sanerio, O. C. Santos, S. Salmeron-Majadas and J. G. Boticario, "Towards Emotion Detection in Educational Scenarios from Facial Expressions and Body Movements through Multimodal Approaches," *ScientificWorldJournal*, 2014.
- [14] E. Um, J. L. Plass, E. O. Hayward and B. D. Homer, "Emotional design in multimedia learning," *Journal of Educational Psychology*, vol. 104, no.2, pp. 485-498, 2012.

- [15] S. D'Mello, B. Lehman, R. Pekrun and A. Graesser, "Confusion can be beneficial for learning," *Learning and Instruction*, vol. 29, pp. 153-170, 2014.3
- [16] L. B. Krithika and G. G. Lakshmi Priya, "Student Emotion Recognition System (SERS) for e-learning improvement based on learner concentration metric," *International Conference on Computational Modeling and Security*, 2016.
- [17] H. B. Holder and S. W. Kirkpatrick, "Interpretation of Emotion From Facial Expressions in Children With and Without Learning Disabilities," *Journal of Learning Disabilities*, vol. 24, no. 3, March 1991.

# Spaced Learning: Electrical Concepts First, Complex Processes Second

## Reducing the time taken to teach concepts to maximize time for complex processes

Ewan MacRae

Centre for Evidence and Social Innovation (CESI)  
Queen's University Belfast  
Belfast, Northern Ireland  
emacrae01@qub.ac.uk

**Abstract---** One of the challenges in technical education is the vast number of concepts that must be transmitted in order to be applied later to higher order thinking skills. The learner is expected to retain concepts for several months before applying knowledge in tests or in the workplace. Within STEM education it is essential for educators to adopt strategies to reduce the cognitive load of their students. This paper proposes the adoption of *Spaced Learning* during STEM courses to assist learners in the long-term memorisation and retrieval of concepts. This pedagogy has been in education for over a hundred years but recent breakthroughs in neuroscience and cognitive psychology has reignited its potential as behavioural scientists better understand how the long-term memory is stimulated. Although the evidence is compelling, research on spaced learning as applied to complex subjects such as STEM has been in short supply. A large-scale trial into science attainment in England is being conducted to discover whether spaced learning can be applied to complex subjects such as STEM and the evaluation report is due to be published in 2020.

**Keywords:** spaced learning, memory, retention, teaching, technical education

### I. INTRODUCTION

Edward L. Thorndike's *The Contribution of Psychology to Education* highlighted the role of memory as exemplifying the kinds of areas in which education would benefit from more psychology (Thorndike, 1910). Psychologists have advocated, for over a hundred years, that teachers practice what has been known as continuous application (James, 1899), distributed practice (Ruch, 1928) or spaced learning (Cain, 1939). Spaced learning is regarded as the oldest of all pedagogies related to memory and retention (Bruce & Bahrck, 1992) dating back to 1885 (Ebbinghaus, 1885/1913). The core of spaced learning as a model of teaching is that similar content should not be packaged together into discrete chunks of time and then left alone until cramming for a test. Ebbinghaus found that 'with any considerable number of repetitions a suitable distribution of them over a space of time is decidedly more advantageous

than the massing of them at a single time' (Ebbinghaus, 1885/1913: 89). Eminent psychologist William James implored teachers to systematically repeat the same content '...on different days, in different contexts, read, recited on, referred to again and again, related to other things and reviewed' (James, 1899: 129). In 1928 psychologist Theodore C. Ruch conducted a systematic review of the literature on spaced learning. This amounted to an examination of twenty spaced learning-style research findings between 1897- 1925 from different 'experimenters' (Ruch, 1928: 21-27). These research papers found positive effects in the spacing effect but no real consensus on timings for input and retrieval, spaces or retention intervals. In 1992, a systematic review of 17 different learning, memory and perception research areas since 1913 found 321 publications on spaced learning, third out of all 17 research areas reviewed (Bruce & Bahrck, 1992: 322). This systematic review also included familiarity with these research areas and found that in the case of spaced learning, academics whose PhD was awarded during or before the 1950s were most familiar with those with PhD awards after 1981 least familiar (Bruce & Bahrck, 1992). This aligns with Dempster (1987) who states spaced learning was prominent in the late 1960s and early 70s. Ironically, it would seem that spaced learning had been on its own forgetting curve. Dempster (1987) regarded spaced learning to be one of the most remarkable findings to emerge from experimental psychology and was perplexed by its failure to be adopted by teachers. His examination of possible barriers concluded by arguing that the only logical argument was a '...paucity of impressive classroom demonstrations of the phenomenon' (Dempster, 1987: 632). The lack of an applied approach to the spacing effect to the day-to-day activities of schooling, such as homework or assessment and testing, had prevented its assimilation into teacher training programmes and mainstream teaching.

### II. A 21<sup>st</sup> CENTURY BREAKTHROUGH

It was not until 2005 that breakthroughs in neuroscience affirmed Ebbinghaus and psychologists' work on the cognitive benefits of spaced learning by discovering how long-term memories are stored in the brain (Fields, 2005). In the three decades preceding the 21<sup>st</sup> century, the length of an inter-study

interval (ISI) was often only given as a matter of seconds (Bahrick & Hall, 2005). The breakthrough by Field (2005) allowed for the physical basis of long-term memory encoding to be understood and how it could be triggered most effectively (Kelley & Watson, 2013). Interest on developing the exact length for an ISI to aide long-term memory had been underway for some time with Menzel et al., (2001) studying honeybees to determine the inter-study interval (ISI). This has renewed educators interest and prioritised the role of memory and pedagogies that can exploit knowledge from the fields of neuroscience and cognitive psychology. The interest currently in science subjects to be able to confidently input concepts into the long-term memories of learners is understandable. Furthermore, research into the efficiency of this method is hugely significant with ‘...one hour’s instruction replacing four months instruction...’ (Kelley & Watson, 2013: 6). The focus of Kelley & Watson (2013) was how the creation of long-term memories should be managed in education. They drew their conclusions from the study by Menzel, et al., (2001) who observed the effect on honeybees of conditioning and post-conditioning timeframes: 30-second, 3-minute, and 10-minute spaces between conditioning, with only the latter effective in aiding long-term memories. Therefore, this article outlines the key components of spaced learning as it currently exists in terms of the pedagogical practices that have been developed in response to these fields of knowledge. Additionally, the ongoing research that is bringing psychology and education closer to the model envisioned by Thorndike over one hundred years ago will be examined. This will be complemented by an examination of the limitations of spaced learning and the wider implications of introducing such a model into classroom practice.

III. IMPLEMENTATION IN STEM CLASSROOMS

Spaced learning can be easily integrated into any education system, curriculum or classroom and requires relatively few resources. Each session can be delivered within an hour-long window and is therefore readily implementable into most education systems worldwide. The following is a basic outline of a typical spaced learning lesson series s applied to basic electricity concepts.

Fig. 1. Spaced Learning Design (O’Hare, et al., 2017)

Lesson 1		Lesson 2		Lesson 3
12-minute Input	Sleep (24-hr space)	12-minute Input	Sleep (24-hr space)	12-minute Input
10-minute distractor activity		10-minute distractor activity		10-minute distractor activity
12-minute Recall		12-minute Recall		12-minute Recall
10-minute distractor activity		10-minute distractor activity		10-minute distractor activity
12-minute Application		12-minute Application		12-minute Application

These three lessons cover revision for England’s GCSE science content for 16-year-olds but may be revised accordingly. When teaching Watts, Amps and Volts the content may be reduced significantly. As shown above, combining the 10-minute space and 24-hour space is vital as it showed the biggest effect in test score performance (O’Hare et al., 2017). The 10-minute spaces from the neuroscientific evidence (Kelley & Watson, 2013) have been shown to be most effective when combined with 24-hour spaces from cognitive psychology (O’Hare, et al., 2017). The understanding from neuroscience of the 10-minute space is that this should allow time for the synapse to rest (Fields, 2005). The figure also refers to how each 12-minute stage contains the exact same content but is presented differently requiring recall and application after the first input stage (Kelley & Watson, 2013; O’Hare et al., 2017). The distractor activities should involve motor skills, such as juggling or clay modelling (O’Hare, et al., 2017) however any acute physical activity is likely to be more beneficial (Hötting, et al., 2016). The presentation of content in O’Hare et al., (2017) used PowerPoint slides with gap fill used in recall. Importantly, the content is not distinct, but interleaved.

Interleaving

Typical STEM textbooks often distinguish between topics by chapter. In learning about basic electricity concepts a textbook may present Watts, Amps and Volts distinctly i.e. each concept will be kept apart to some extent. This is commonly referred to as *blocked practice* and spaced learning’s potency is increased when the content is *interleaved* (Kang, 2016a). Figure2. demonstrates how the presentation and learning differs from traditional methods:

Fig. 2. Blocked v Interleaved: basic electricity concepts

Blocked			
Lessons 1-4	Lessons 5-9	Lesson 10-14	
W	A	V	Test
Interleaved			
Lesson 1	Lesson 2	Lesson 3	
W, A, V	W, A, V	W, A, V	Test

W = Watts, A = Amps, V= Volts

As opposed to teaching *all* of the Watts content first, then *all* of the Amps content and finally *all* of the Volts content, interleaving mixes the content together. The same content is repeated on different days and students should begin to notice improvements by the second or third presentation. The number of lessons needed is vastly reduced: the assumption behind spaced learning is ‘...one hour’s instruction replacing four months instruction...’ (Kelley & Watson, 2013: 6) as the content has been intensified and condensed.



This leaves more time for teaching the complex processes. The immediate implications of the example in figure 2. for teachers is that it requires a greater level of future planning and organization than would normally be the case in blocked practice. The benefits of interleaving are significant. In an example from art, associating paintings to their respective painter in an inductive learning approach (noticing), a study showed that not only was achievement better when interleaved but that mind wandering had reduced and discrimination between concepts or ideas increased (Metcalf & Xu, 2016).

The final consideration for implementation in a STEM classroom is the PowerPoint presentation slides and their impact. If teachers have designed the structure of the lesson and its timings to conform with the principles of spaced learning and also dispersed the content in line with interleaving, the last major consideration is how to reduce cognitive load. This is important, for if teachers are to commit themselves to an appreciation of the mind and brain in education, all elements must be geared towards this aim. Table 16.1 is taken from Hattie & Yates (2014: 150) and is relevant to the implementation of spaced learning and also to the understanding of cognitive load. Cognitive load theory (CLT) recognizes the burden put on learners when they are exposed to many unfamiliar or new concepts and is particularly onerous in STEM education. Reducing cognitive load assists novices and recognizes the learner’s inherent limitations (Ibid., 150).

defined as ‘...whenever a person makes a deliberate conscious attempt to place information in the long-term memory’ (Hattie & Yates, 2014: 162). Evidence suggests that pupils of low prior attainment can really benefit from having a teacher who uses mnemonics in class (Hattie & Yates, 2014). As such, memory has particular importance when it comes to inclusive education and reducing inequalities in attainment. Teachers therefore need to be acutely aware of memory and metacognitive strategies. The 10-minute period has become the standard ISI used in spaced learning RCTs (O’Hare et al., 2017). A period of post-conditioning of several hours, equivalent to a sleep, is also required (Menzel et al., 2001) and together offer best practice (O’Hare, et al., 2017). The last key important point for teachers, however, is the ability to manipulate the length of time a pupil will retain information, or the retention interval. If pupils’ tests are a month away, teachers can leave a 3 or even 4-day gap between repeated content: the general rule of thumb is 10-20% of the intended retention interval (Cepeda, et al., 2008; Kang, 2016a). Thus, depending on the syllabus, the 10-minute and 24-hour spaces over three lessons (figure 1.) longer from cognitive psychology also spaces of weeks or months offer intriguing possibilities for educators. These spaces will be discussed in the following sub-section under the terms conditioning and post-conditioning, although the conditioning 10-minute spaces are referred to as inter-study interval (ISI) also.

IV. LIMITATIONS AND AREAS OF CONCERN

Spaced learning has important ramifications for inductive learning approaches and the potential for critical thinking. Dempster (1987) felt the potential of spaced learning in memorization tasks did not apply to concepts or higher-order thinking skills. Although Kang (2016a) argues that it assists in reasoning, problem solving, response times and subsequent learning, transfer and comprehension there is more research needed here. Writing ten years after Thorndike (1910) on educational experiments in England, Alice Woods (1920) questioned the extent to which Thorndike could apply psychology to education, as ‘...whenever experiments deal with human beings, even when they concern only such facts as fatigue, attention, memory, it is hard to get rid of conditions which will affect the results’ (Woods, 1920: 77). Such conditions in schools might take the form of variances in students’ backgrounds, their home life, self-efficacy, prior learning, the class size, the pupil-teacher relationship and other conditions that may affect the brain such as the quality of sleep students are getting. While memory-based pedagogies such as spaced learning have to be considered, the effect has been shown to be smaller on high prior attaining (HPA) students than it does on low prior attaining (LPA) students (Hattie & Yates, 2014). Depending on the institution or learner level, spaced learning may not be suitable or desirable. The potential of interpolation of testing to improve learning challenges some of the effects within spaced learning. Szpunar et al., (2013) found that a formative assessment

Table 16.1 Principles of learning described in the cognitive load research literature

PRINCIPLE	RESEARCH FINDING
Worked example	As novices, we need to see how knowledge applies to specific cases since problem solving fails to further develop our knowledge
Multimedia	We learn better when words accompany pictures, rather than from words alone. Our minds combine words and images effectively
Contiguity	Words should be placed as close to the relevant defining image as possible
Temporal Contiguity	We will learn better when words and pictures are presented simultaneously, rather than successively
Coherence	We learn better when extraneous information is removed. In the case of novices, clarity readily outweighs elaboration. (But it is the reverse with expert learners)
Modality	We learn better when we listen to words in combination with images, rather than having to read text while looking at the image.
Redundancy	Listening to and reading the same information is not efficient and will reduce overall learning
Signalling	We benefit from any cues that highlight critical information
Pacing	We benefit from being able to control the pace of incoming information
Concepts first	We learn concepts at a basic level before applying them in any complex process
Personalisation	You learn better when personal pronouns are used (such as in this sentence)

(Hattie & Yates, 2014: 150)

Table 16.1 can act as a guide for teachers designing their own slides for spaced learning so as to present concepts in a systematic fashion as opposed to an *ad hoc* approach that could unwittingly be increasing the cognitive load on learners. For instance, it is important to put pictures and words together on the same slide, to put them as close together as possible, or remove the words if the teacher will explain an image. If the students are novices, the teacher should explain the fundamentals only but can discuss in detail if the students are at an advanced stage.

Justification for adopting this approach has largely revolved around the need for teachers to be more evidence-informed in their practice and to consider the mind, brain, and education (MBE) movement. Mnemonics in its broadest sense has been

approach to lectures, interspersing the content with memory tests or quizzes improved learning, reduced mind-wandering and cognitive load. Although this learning included note-taking, was formative and was not repeated on different days there is justification for comparison. Another area necessary to scrutinize spaced learning is the idea that spaced learning lessons contain regular testing through recall and application after the input stage. A study conducted on proactive interference found that groups with interpolated tests performed similarly to a group with just the warning of a summative test (Weinstein, et al., 2014). The presence of a recall and application stage after the input in spaced learning functions as a test with the academic term positioning of spaced learning immediately prior to a national high stakes exam raising further the issue of testing as a moderator variable. Furthermore, in the study by O'Hare et al., (2017) the distractor activity, where students spent the 10-minute ISI juggling, may have been a mediator variable: studies have shown that acute physical activity has an impact on brain development and long-term memory (Hötting, et al., 2016). Lastly, there are wider implications at stake. One of the key gains for policymakers and institutions is that spaced learning may be able to reduce the time it takes to cover a syllabus, with '...one hour's instruction replacing four months instruction...' (Kelley & Watson, 2013: 6). If proven, '...the spacing effect has immediate and obvious implications for how time in the classroom may be distributed optimally' (Dempster, 1988: 628). Will this translate into more support for teachers and learners or a reduction in lessons or even school hours? Similarly, will the training of teachers be reduced as teaching becomes more automated? Ultimately, the main barrier for STEM education is that little of the research on spaced learning has involved complex kinds of learning (Kang, 2016a). The examples widely cited are from foreign languages or, as this paper itself has demonstrated, relies on findings from subjects such as Art. There is research into spaced learning in medical education and in revision for England's GCSE science exams and this will contribute to the growing body of knowledge on spaced learning for STEM. The evaluation report, due to be published in 2020 (O'Hare et al., 2017) should be monitored closely by educators in this field. In the meantime, educators who wish to implement spaced learning would be well justified based on its heritage, promise of evidence and ongoing interest among researchers and education systems into this pedagogy.

#### ACKNOWLEDGMENT

E.M would like to thank the Department for the Economy of Northern Ireland, the Centre for Evidence and Social Innovation (CESI) and Queen's University Belfast for their support. Thank you especially to Dr Liam O'Hare in relation to the ongoing research into teachers' experiences in a trial and spaced learning and to Dr Karen Kerr and Dr Laura Dunne.

#### REFERENCES

- [1] Bahrick, H. P., & Hall, L. K. (2005). The importance of retrieval failures to long-term retention: A metacognitive explanation of the spacing effect. *Journal of Memory and Language* 52:4, 566-577.
- [2] Bruce, D., & Bahrick, H. P. (1992). Perceptions of past research. *American Psychologist* 47:2, 319-328.
- [3] Cain, L. F., & Willey, R. D. V. (1939). The effect of spaced learning on the curve of retention. *Journal of Experimental Psychology* 25:2, 209-214.
- [4] Dempster, F. N. (1987). Effects of variable encoding and spaced presentation on vocabulary learning. *Journal of Educational Psychology* 79, 162-170.
- [5] Dempster, F. N. (1988) The spacing effect: A case study in the failure to apply the results of psychological research *American Psychologist* 43:8, 627-634
- [6] Dunlosky J., Rawson K., Marsh E., Nathan M., Willingham D., (2013) Improving students' learning with effective learning techniques: promising directions from cognitive and educational psychology *Psychological Science in the Public Interest* 14:1, 4-58
- [7] Ebbinghaus, H. (1885/1913). *Memory: A contribution to experimental psychology*. (Translated by H. A. Ruger and C. E. Bussenius). New York: Teachers College, Columbia University. (Also available 1964 and 1987, New York: Dover Publications. Original published in 1885).
- [8] Fields, R.D. (2005) Making memories stick. *Scientific American* 292 (February), 74-81
- [9] Hattie, J., & Yates, G C. (2014) *Visible learning and the science of how we learn*. Routledge
- [10] Hötting, Kirsten., Schickert, Nadine., Kaiser, Jochen., Röder, Brigitte and Schmidt-Kassow, Maren. (2016) The Effects of Acute Physical Exercise on Memory, Peripheral BDNF, and Cortisol in Young Adults, *Neural Plast.* 1-12
- [11] James, W. (1899). *Talks to teachers on psychology: and to students on some of life's ideals*. New York: Henry Holt.
- [12] Kang, S. H. K. (2016a). Spaced repetition promotes efficient and effective learning: policy implications for instruction, *Policy Insights from the Behavioral and Brain Sciences* 3:1, 12-19
- [13] Kang, S. H. K. (2016b). The benefits of interleaved practice for learning. In J. C. Horvath, J. Lodge, & J. A. C. Hattie (Eds.), *From the laboratory to the classroom: Translating the learning sciences for teachers*. New York: Routledge. 79-93
- [14] Kelley, P. and Watson, T. (2013) Making long-term memories in minutes: a spaced learning pattern from memory research in education *Frontiers in Human Neuroscience* 7: 589, 1-9
- [15] Menzel, R., Manz, G., Menzel, R., and Greggers, U. (2001). Massed and spaced learning in honeybees: the role of CS, US, the intertrial interval, and the test interval. *Learning & Memory* 8, 198-208 doi: 10.1101/lm.40001
- [16] Metcalfe, J., & Xu, J. (2016) People mind wander more during massed than spaced inductive learning, *Journal of Experimental Psychology: Learning, Memory and Cognition* 42:6, 978-84 doi: 10.1037/xlm0000216
- [17] O'Hare, Liam., Stark, Patrick., McGuinness, Carol., Biggart, Andy & Thurston, Allen (2017) Spaced learning: the design, feasibility and optimisation of SMART Spaces, evaluation report and executive summary, [Unpublished] [https://educationendowmentfoundation.org.uk/public/files/Projects/Evaluation\\_Reports/EEF\\_Project\\_Report\\_SpacedLearning.pdf](https://educationendowmentfoundation.org.uk/public/files/Projects/Evaluation_Reports/EEF_Project_Report_SpacedLearning.pdf)
- [18] Ruch, T. C. (1928). Factors influencing the relative economy of massed and distributed practice in learning *Psychological Review* 35, 19-45.
- [19] Szpunar, Karl K., Khan, Novall Y., Schacter, Daniel L. (2013) Interpolated Memory Tests Reduce Mind Wandering and Improve Learning of Online Lectures *Proceedings of the National Academy of Sciences (PNAS)* 110: 16, 6313-7 doi: 10.1073/pnas.1221764110
- [20] Thorndike, Edward L. (1910) The contribution of psychology to education *Journal of Educational Psychology* 1:1, 5-12

- [21] Weinstein, Y., Gilmore, A. W., Szpunar, K. K., & McDermott, K. B. (2014). The role of test expectancy in the build-up of proactive interference in long-term memory. *Journal of Experimental Psychology: Learning, Memory, and Cognition*, 40:4, 1039-1048
- [22] Woods, A. (1920) Educational experiments in England. Methuen & Co. Ltd, London

# Understanding Radiation Improvement in Electrically Small Dipole and Loop Antennas Using Perturbed Two-Wire Transmission Line Model

Apisak Worapishet

Mahanakorn Microelectronics Research Center, MMRC  
 Mahanakorn University of Technology  
 140 Cheumsampan Rd., Nong-Chok, Bangkok, Thailand. Email: *apisak@mut.ac.th*

**Abstract** — A perturbed two-wire transmission line (TWTL) model for intuitive understanding of the radiation efficiency in the standing-wave antenna type, namely the dipole and loop antennas, as well as their derivatives, is presented. The simplistic model enables qualitative prediction of the input impedance, current/voltage distributions, as well as resonance mode of operation. These can be inspected to gain insight into the operation of the typical dipole/loop antennas, and their electrically small counterparts with and without the inductor-loading for the radiation efficiency improvement. The usability of the model is verified via extensive electromagnetic simulations of the antennas operating at an RFID frequency of 925 MHz. Discussion on further applications of the model are also provided.

**Keywords** — Dipole antenna, loop antenna, short dipole, small loop, inductor loading.

## I. INTRODUCTION

With the advent of state-of-the-art wireless systems and applications, portable wireless devices have witnessed a rapid expansion and essentially become indispensable in today's and future's human society. One of the key building elements of the devices is the antenna that serves as a gateway between the free-space electromagnetic waves and on-board electrical signals. As the form factor continues to shrink whereas the operating carrier frequency does not scale proportionally, the requirement of *in-situ* small size antennas has imposed serious constraints on their designs and radiation performances.

Although numerous antenna structures, materials and techniques have been developed to address the size reduction issues over the past decade [1], it is of critical importance to fundamentally understand how the radiation performance of the antenna structures as simple as the electrically small dipole and loop antennas can be improved using the coil or inductor loading. However, either too brief explanation or too involved mathematical analysis has been provided [2], [3], thereby offering limited underlying operation.

It is thus the purpose of this paper to explore the use of the two-wire transmission line (TWTL) and its perturbation model [4], [5], [6] to provide an intuitive understanding of the physical mechanism underlying the impact of the inductor loading on the resonant frequency and current/voltage distribution of the electrically small dipole and loop antennas that results in radiation efficiency improvement.

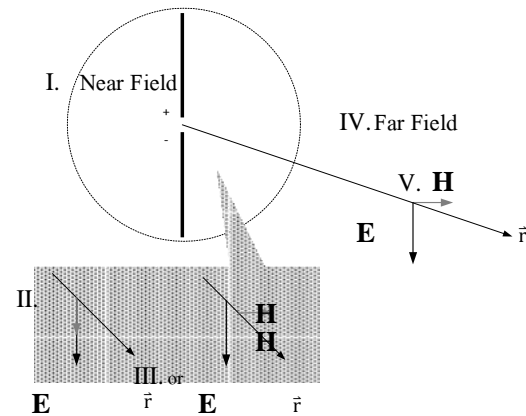
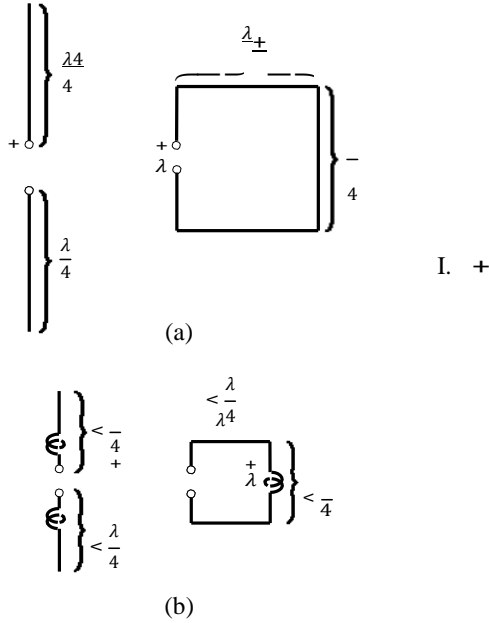


Fig. 1 Illustrations of E and H fields in near and far field zones of dipole antenna.

The organization of the paper is as follows. Section II briefly discusses the radiation efficiency and typical factors affecting the performance. The use of the TWTL to model the dipole and loop antennas is outlined in Section III. The model equipped with the perturbation network/termination is described and subsequently utilized to gain insight into the radiation improvement in the antennas loaded with series inductors in Section IV. Verification of the model is provided via simulations in Section V, and conclusion is given in Section VI.

## II. ANTENNA RADIATION EFFICIENCY

An antenna is a reciprocal device that can provide a conversion between free-space electromagnetic waves and on-circuit electrical voltage/current signals. According to the Poynting's theorem [4], the main antenna characteristic is the ability to transmit or receive flow of real power associated with simultaneous time-varying electric and magnetic fields at a spatial location in its surrounding that satisfy the condition of non-zero pointing vector  $\mathbf{S} = \mathbf{E} \times \mathbf{H}^*$ . This is illustrated by the so called far field in Fig. 1 where the E and H field components are perpendicular. Also surrounding the antenna are stored reactive energies of electric and magnetic fields that flow back and forth between the nearby space and the antenna source/load. This so called near field is also illustrated, for examples, by in-phase and spatially separate E and H fields in Fig. 1.

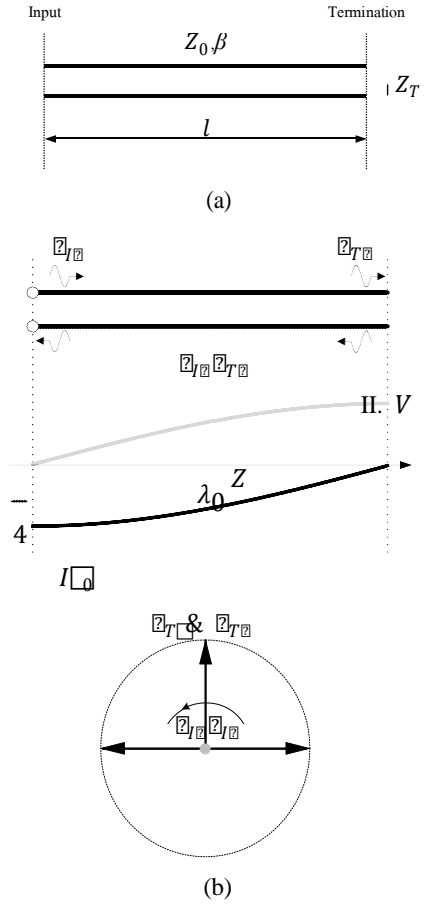


**Fig. 2** (a) Typical  $\lambda/2$  dipole and  $\lambda$  loop antennas, (b) inductor-loading configurations for electrically small dipole/loop antennas.

One of the key characteristics of an antenna is the radiation efficiency. It indicates how efficient one can convert between the electromagnetic and electrical powers. The radiation efficiency is determined by the ratio of the radiation resistance (or input resistance) and the total resistance of the antenna, which includes the conductor and dielectric losses. Another important factor is the relative input impedance of the antenna as compared to the source/load, because this determines the complexity, component spreading, and hence the loss associated with the matching network.

In general, a radiation resistance somewhat higher than the conductor/dielectric loss resistance, and an input impedance close to the conjugate impedance of the source/load or cable connected to the antenna is desired for a high efficiency. For a coaxial feed, the radiation resistance close to the coaxial line's characteristic impedance and zero reactance are desired so that no/minimum matching network is required, thereby minimizing the associated loss. For a direct antenna feed by a transmitter/receiver, the conjugate matching condition requires the radiation resistance to be close to the input/output resistance, and the *net* reactance to be zero. Note that the zero reactance is equivalent to a resonance condition. Since the real part of the source, load or cable is typically up to a few tens of Ohms, the *series* resonance type is normally required.

As shown in Fig. 2(a), the minimum *overall* length of the dipole that results in the series resonance condition is equal to  $\lambda/2$ . For the square-loop antenna, this is equal to  $\lambda$  [4]. As the length is shortened, the resonance is shifted to a higher frequency and the current/voltage distribution along the antenna structure is modified. As a result, the radiation efficiency is reduced. Fig. 2(b) depicts typical inductor-



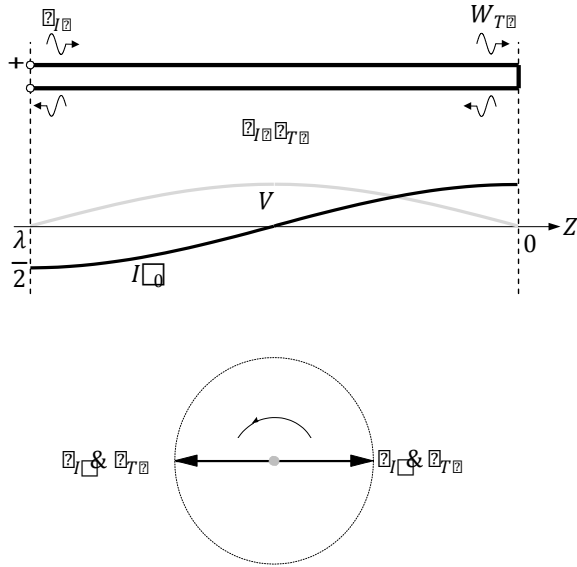
**Fig. 3** (a) TWTL model (b) open-ended TWTL model, its current/voltage distributions along one arm (with current multiplied by  $Z_0$  for scale normalization), and associated phasor diagrams.

loading configurations for the dipole and loop antennas for improving the radiation efficiency [2], [3].

### III. TWTL ANTENNA MODEL

A two-wire transmission line model that can be employed to intuitively study the radiation efficiency in the dipole and loop antennas is outlined in this section. Consider a two wire uniform transmission line in Fig. 3(a) where  $Z_0$  is the characteristic impedance in Ohm,  $\beta$  is the phase constant in rad/m,  $l$  is the length in m, and  $Z_T$  is the termination impedance. By applying a voltage across the input terminal, an electric field is created between the two conductors. This electric field also results in a movement of charges or current in the conductors, hence a magnetic field is created. As a consequence, the simultaneous E and H fields between the two wires form an electromagnetic (EM) wave propagating along the transmission line. Upon reaching the termination, whether or not there will be a wave reflection depends on  $Z_T$ . For the case of interest where  $Z_T$  is assumed to be either infinite (open termination), zero (short termination), or imaginary (purely inductive or capacitive), there is a total reflection at  $Z_T$  with an equal magnitude and only a phase change. The reflected wave combined with the incident wave, in effect, causes *standing wave* patterns along the line.



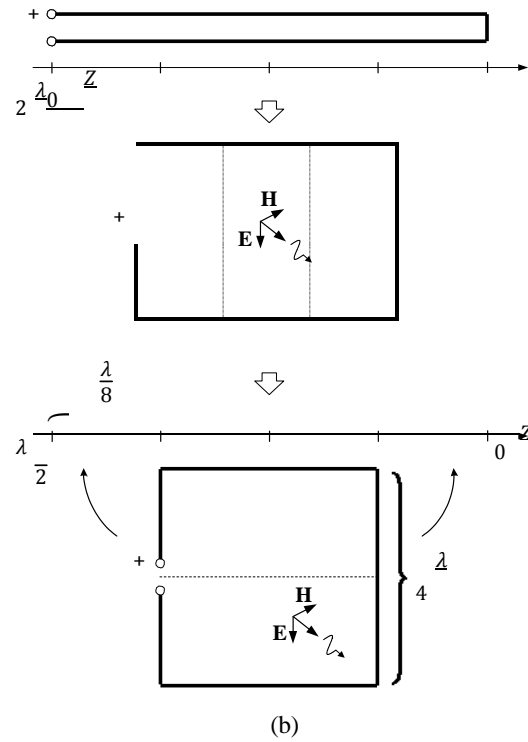
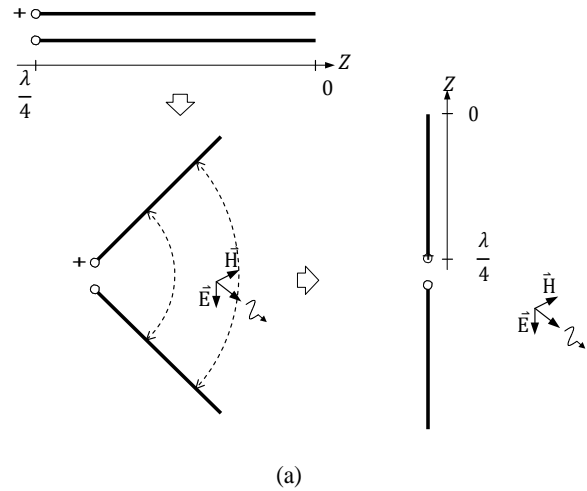


**Fig. 4** (a) Short-ended TWTL model (b) current/voltage distributions and associated phasor diagrams.

For an open termination  $Z_T = \infty$  under a sinusoidal voltage with the length of  $l = \lambda/4$  or the electrical length of  $\beta l = \pi/2$ , the magnitude distributions of voltage and current standing waves (representing the E and H field magnitudes, respectively) along the transmission line are shown in Fig. 3(b). Also given in Fig. 3(b) are the relative phasors representing the one-round travel of the incident waves at the input ( $W_{TI}$ ), the incident/reflected waves at  $Z_T$  ( $W_{TI}$  and  $W_{TR}$ ), and the reflected wave returning to the input ( $W_{IR}$ ). Note that  $W$  can be either a voltage or current wave.

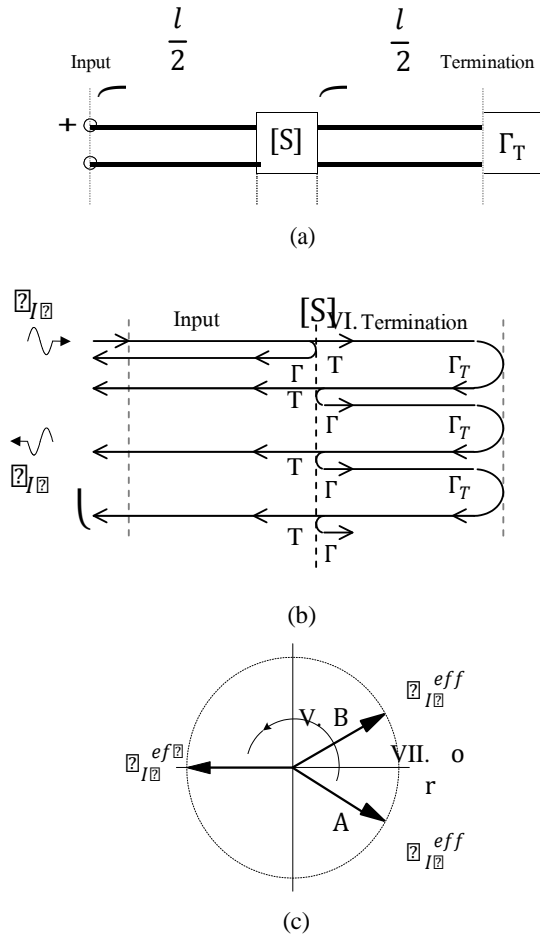
Since  $Z_T = \infty$ ,  $W_{TR}$  undergoes no phase change and thus  $W_{TR}$  and  $W_{TI}$  are in phase. In this way, after travelling one round at the distance  $2l = \lambda/2$ , the phase of  $W_{IR}$  leads that of  $W_{TI}$  by  $+\pi$  rad. For the voltage wave, where the total is the sum between the incident and reflected waves, this results in a complete cancellation between the  $V_{IR}$  and  $V_{TI}$ , yielding a zero voltage wave magnitude at the input. For the current wave, where the total is the difference, this results in a complete cancellation between the  $I_{TR}$  and  $I_{TI}$ , yielding a zero current standing wave magnitude at the open termination. The overall current/voltage distributions along the line as given in Fig. 3(a) indicates a series resonance condition at the input of the open-ended TWTL model for the  $\lambda/2$  dipole.

By following a similar explanation for a short termination  $Z_T = 0$  and  $l = \lambda/2$ , the voltage and current standing wave distributions and the associated phasors are given in Fig. 4. Notice that  $W_{TR}$  and  $W_{TI}$  are out of phase because  $W_{TR}$  undergoes  $-\pi$  rad phase change at the short termination. After travelling one round, the phase of  $W_{IR}$  also leads that of  $W_{TI}$  by  $+\pi$  rad. For the voltage waves, the resulting phasors yields a complete cancellation between  $V_{IR}$  and  $V_{TI}$ , and between  $V_{TR}$  and  $V_{TI}$ . Thus, both the input and short termination exhibit zero voltage magnitude. On the other hand for the current waves, the phasors yields a complete



**Fig. 5** TWTL model transitions to antenna to (a) open-ended TWTL to dipole, (b) short-ended TWTL to square-loop antenna.

addition between  $I_{IR}$  and  $I_{TI}$ , and between  $I_{TR}$  and  $I_{TI}$ . Thus, the input and short termination exhibit twice the current magnitude of the incident current wave, but with opposite phase. The overall distributions given in Fig. 4(a) also indicates a series resonance at the input of the short-ended TWTL model for the typical  $\lambda$  loop antenna.



**Fig. 6** (a) Perturbed TWTL model, (b) illustration of multiple reflections and (c) phasor diagrams of input incident/reflected waves.

In the above explanation, it is assumed that the spacing between the two wires is so small that the EM wave is confined within the transmission line structure. As the two wires begins to move apart as shown in Fig. 5(a) under the open termination, and Fig. 5(b) under the short termination, the spacing between the wires becomes larger, and the E and H fields extend more into the surrounding space. As a result, an EM wave that propagates into free space can be formed. As also shown in Fig. 5(a) and 5(b), the flared open-end two-wire structure ultimately takes the form of the dipole antenna. On the other hand, the vertically stretched short-end two-wire structure eventually takes the form of the square-loop antenna.

In fact, the dipole/loop structure of Fig. 5 can be considered as a form of open/short-ended transmission lines with two wires extending in the opposite direction and the input voltage excitation in the middle. In this case however, the characteristic impedance  $Z_0$  between the same distant points from the middle of the wire pair is non-uniform, and there is a free-space radiation. As the wave propagation is guided by the two opposite wires, there are both continuous partial reflection and magnitude attenuation due to the radiation. Thus, no complete cancellation of waves as in the case of the TWTL model occurs in the antenna. Nevertheless, the voltage and current standing wave distributions along both wires are still close to those of their

corresponding uniform TWTL models. Following this, the TWTL can be employed as a simplistic and intuitive model to understand the radiation efficiency of the dipole/loop structures and their derivations.

#### IV. PERTURBED TWTL MODEL FOR INDUCTOR-LOADED ANTENNAS

Having discussed the simplistic modeling of the standing wave distributions in the dipole/loop antennas using the open/short TWTL, we are ready to use the model to examine how the inductor-loading can improve the radiation efficiency of their electrically small versions.

##### 4.1 Perturbed TWTL Model

Fig. 6(a) shows the generalized structure of the perturbed TWTL with a  $Z_T$ -termination and a two-port S-parameter network inserted along the line. Note that the network can be of inductor or any other type, such as capacitor, step impedance etc. Its location can also be anywhere along the transmission line, but without loss of generality, it is located in the middle for the sake of analysis simplification. With reference to typical inductor-loading dipole and loop antennas in Fig. 2, for the inductor-loading dipole, we have  $Z_T = \infty$  and a series inductor network in the model of Fig. 6. For the inductor-loading loop,  $Z_T$  is of an inductor termination and no perturbation network is included.

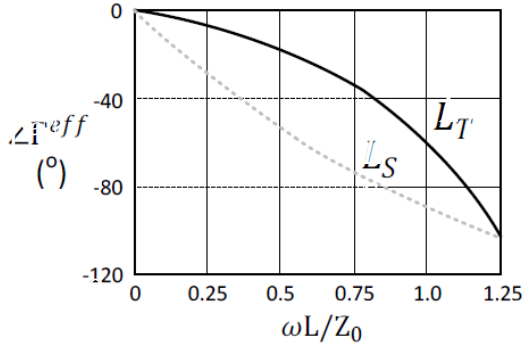
##### 4.2 Radiation Improvement using Inductor-Loading

###### 4.2.1 Resonance shifting perspective

The perturbed transmission line model has been studied for the case of step impedance networks in [5], [6]. Based on phasor diagrams of waves propagating along the line, it was shown that the step perturbation results in a resonance frequency shifting in the perturbed open/short-ended transmission line.

By following the analysis similar to [6], the incident/reflected waves and their phasor diagrams of the perturbed line are illustrated in Fig. 6(c) and 6(d), respectively. Note that  $\Gamma$ 's and  $T$ 's, respectively, represent the reflection and transmission coefficients due to the network.  $\Gamma_T$  represents the reflection coefficient at the termination. With the S parameters referenced to  $Z_0$ , we have  $\Gamma = S_{11} = S_{22}$ , and  $T = S_{12} = S_{21}$ . It is apparent from the figure that, in addition to a reflection at the  $Z_T$  termination, the perturbation network gives rise to multiple reflections and these essentially modify the relative phase between the incident and reflected waves at a location along the TWTL structure. The reflections due to  $Z_T$  and/or the network, as a consequence, effectively results in a change in the phase constant ( $\beta = 2\pi/\lambda$ ), hence a change in the effective wavelength  $\lambda$  and therefore the resonance frequency of the perturbed TWTL.

Consider the case that the multiple reflections result in a larger phase difference as shown by the vector A in Fig. 6(c). The incident wave  $W_{II}$  leads the effective reflected wave  $W_{eff IR}$  (total vector sum of multiple reflected waves) by more than the phase value without the perturbation from the network and/or termination ( $+\pi$  rad for both the  $\lambda/4$  open-ended and  $\lambda/2$  short-ended lines as indicated in Fig. 3 and 4). This implies that the effective phase constant  $\beta^{eff}$  is higher, which in turn yields a shorter effective wavelength  $\lambda$ , and a lower resonance frequency of the perturbed TWTL.



**Fig. 7** Numerical plots of added phase due to  $\Gamma^{eff}$  versus  $\omega L/Z_0$  for open-ended  $\lambda/4$  TWTL with  $L_S$  loading (solid line) and short-ended  $\lambda/2$  TWTL with  $L_T$  termination (dotted line).

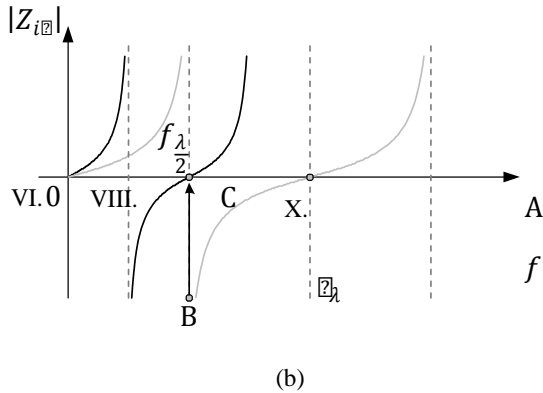
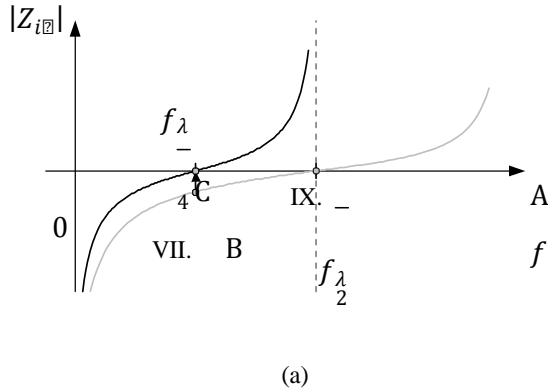
$$\Gamma^{eff} = \left( \Gamma + \frac{(1 - \Gamma)^2 \Gamma_T e^{-j\beta l}}{1 - \Gamma \Gamma_T e^{-j\beta l}} \right) e^{-j\beta l} \quad (1a)$$

$$\Gamma = \frac{jz_{nS}}{1 + jz_{nS}} \quad (1b)$$

$$\Gamma_T = \frac{jz_{nT}}{1 + jz_{nT}} \quad (1c)$$

where  $z_{nS} = \omega L_S/Z_0$ , and  $z_{nT} = \omega L_T/Z_0$ ,  $\omega$  is the radian frequency,  $L_S$  and  $L_T$  are the inductor values of the network and termination, respectively. Since the perturbed TWTL is lossless, the magnitude of  $\Gamma^{eff}$  is always unity.

Fig. 7(a) shows the numerical plot of the phase shift added to  $W_{IR}^{eff}$  by  $\Gamma^{eff}$  versus the normalized impedance  $z_{nS} = \omega L_S/Z_0$  under conditions  $Z_T = L_T = \infty$  and  $l = \lambda/8$  at the operating frequency, for an inductor-loaded dipole model. Fig. 7(b) shows the phase plot versus the normalized impedance  $z_{nT} = \omega L_T/Z_0$  under conditions  $Z_S = L_S = 0$  and  $l = \lambda/4$  for an inductor-loaded loop model. It is evident from the plots that more phase difference is introduced by the inductor loading, thereby resulting in a shorter effective wavelength, and hence a reduced resonance frequency. This indicates that the inductor-loading can restore the series resonance condition in the electrically small dipole/loop antennas and thus their radiation efficiency can be improved. Fig. 8 illustrates the series resonance restoration by plotting the changes in input impedances versus frequency of the dipole and loop antennas with and without their corresponding inductor loading.



**Fig. 8** Impedances vs frequency of (a) typical  $\lambda/2$  dipole (point A),  $\lambda/4$  dipole (point B), and inductor-loaded  $\lambda/4$  dipole (point C), (b) typical  $\lambda$  loop (point A),  $\lambda/2$  loop (point B) and inductor-loaded  $\lambda/2$  loop (point C).

On the contrary, when the multiple reflections yields a smaller phase difference as shown in Fig. 6(d), the incident wave  $W_{II}$  leads the effective reflected wave  $W_{IR}^{eff}$  by less than the value without the network. Thus, the effective phase constant  $\beta^{eff}$  is smaller, yielding a longer effective  $\lambda$  and consequently a higher resonance frequency.

With the use of the multiple reflection theory outlined in [7], it can be shown that the effective input reflection coefficient  $\Gamma^{eff}$  of the perturbed TWTL model with the inductor loading is given by

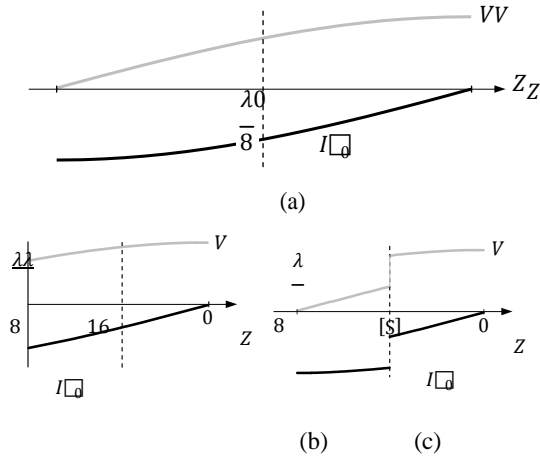
#### 4.2.2 Current/voltage distribution perspective

It is instructive to investigate the distributions of the current/voltage standing waves as a result of the inductor loading in order to provide insight on the resonance shifting in the perspective of E and H fields.

Let us first consider the uniform TWTL model of the  $\lambda/2$  dipole and  $\lambda$  loop antennas. For the sake of explanation, the distributions associated with the  $\lambda/4$  open-ended TWTL are repeated in Fig. 9(a). It is evident that the overall current and voltage distributions are balanced, thereby yielding balanced E and H fields. This consequently yields zero net near field or a resonance condition in the  $\lambda/2$  dipole. The resonance is of a series type because the magnitude of the voltage standing wave at the TWTL's input is zero.

When the length is reduced by half to  $\lambda/8$ , the distributions are given in Fig. 9(b). Because the incident/reflected waves travel at half the distance, the distributions equivalent to the open-ended halve of Fig. 9(a) is obtained. The resulting voltage/current distributions become unbalanced with an overall larger E field. This indicates a non-resonance condition with excess electric near field, thereby reducing the radiation efficiency.

The distributions associated with the  $\lambda/2$  short-ended TWTL and its  $\lambda/4$  counterpart to model the  $\lambda$  square-loop antennas and its  $\lambda/2$  version are given in Fig. 10(a) and 10(b), respectively. Although the  $\lambda/2$  loop exhibits balanced E/H fields, the resulting resonance is of a parallel type because



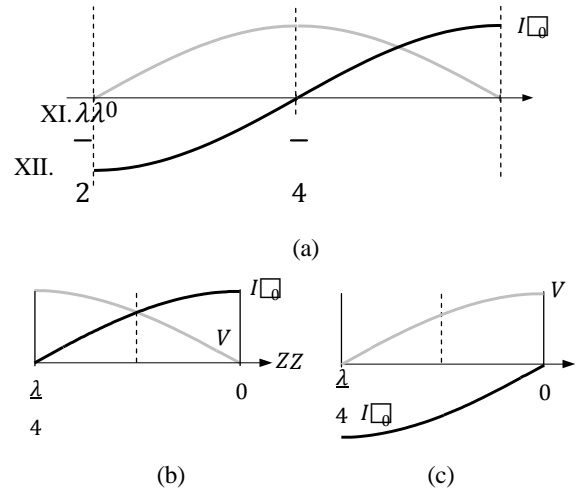
**Fig. 9** Current/voltage distributions of (a) typical  $\lambda/2$  dipole antenna, (b)  $\lambda/4$  dipole and (c)  $\lambda/2$  dipole with inductor loading network in the middle of each arm.

the current magnitude at the TWTL's input is zero. This implies that the radiation resistance in the  $\lambda/2$  loop antenna is much higher than that of a typical connected source or load, thereby entailing higher loss in the matching network and an inferior radiation efficiency to its series-resonant  $\lambda$  loop counterpart.

Let us reconsider the perturbed TWTL model in Fig. 6. As described in Section III, the distribution is mainly determined by the relative phase between the incident and reflected waves at a point along the line. By inspecting the termination section of the model, it is seen that there are multiple pairs of incident/reflected waves. Each pair gives rise to the same voltage/current distribution pattern determined by  $\Gamma_T$ , with consecutive changes in the magnitude and phase by  $\Gamma$ . Since the total distribution is the vector sum of all the distributions, the pattern is maintained with only magnitude modification. At the input section of the model, since the magnitude of  $\Gamma^{eff}$  is unity, the distributions are equivalent to those along the input of the uniform TWTL counterpart with the electrical length of  $\angle\Gamma^{eff}$  rad.

For the inductor-loaded  $\lambda/4$  dipole of Fig. 2(a) with the network inductance  $L_S$  chosen such that  $\angle\Gamma^{eff} = -\pi$  at the operating frequency, by applying the above discussion, the modified current/voltage distributions along the input section are shown in Fig. 9(c). Also given are the distributions along the termination section. Clearly in the figure, the E and H fields are balanced, and thus the series resonance are restored in the inductor loaded dipole, with consequent improvement to its radiation efficiency.

For the inductor-loaded  $\lambda/2$  loop of Fig. 2(b), the above discussion at the termination section with  $\Gamma = 0$  can be applied. By choosing the terminating inductance  $L_T$  such that  $\angle\Gamma^{eff} = -\pi$ , the distributions along its inductor-loaded  $\lambda/4$  TWTL model become as shown in Fig. 9(c). Clearly, the balanced E and H fields are still maintained, but the resonance is modified from parallel to series type because the voltage standing wave is zero at the input. Following this, an improved radiation efficiency is obtained.



**Fig. 10** Current/voltage distributions of (a) typical  $\lambda$  loop antenna, (b)  $\lambda/2$  loop and (c)  $\lambda/2$  loop with inductor loading at termination.

Type	$l$ (mm)	$L_S$ (nH)
Typical @ $\lambda/2$	100.00	-
Small @ $\lambda/4$	50.00	-
Small @ $\lambda/4$ + L-loading	50.00	29.00

**Table I** Dipole antenna dimensions

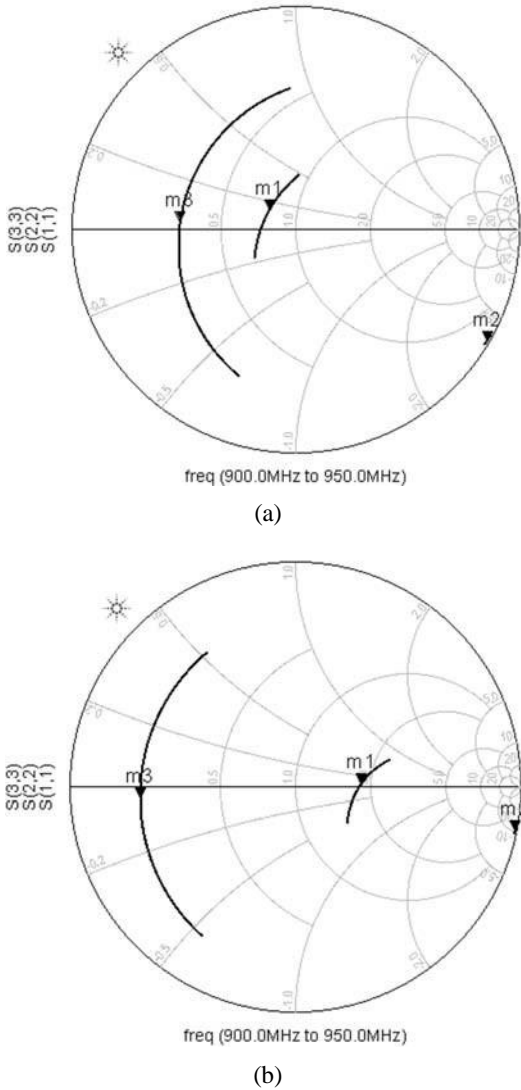
Type	$l$ (mm)	$L_T$ (nH)
Typical @ $\lambda$	80.00	-
Small @ $\lambda/2$	40.00	-
Small @ $\lambda/2$ + L-loading	40.00	90.00

**Table II** Loop antenna dimensions

## V. VERIFICATION OF PERTURBED TWTL MODEL

In this section, the usability of the perturbed TWTL model to visualize the current/voltage distribution (equivalently the H and E fields), as well as to indicate the resonance mode is verified. Based upon the student version of the CST platform [8], simulations of the dipole and loop antennas, along with their small counterparts with and without the inductor loading are given. The simulation frequency is between 900 to 950 MHz in order to cover the operating RFID frequency located in Thailand at 925 MHz. The antennas are of a PCB type, using the Taconic-10 PCB substrate with  $\epsilon_r \approx 10.1$ . All the antennas' dimensions are summarized in Table I and II. Note from the table that the dipole and loop antennas exhibit different optimum lengths due to different effective wavelength  $\lambda$ . This is because the propagating waves along the antenna structures extend differently into the substrate and surrounding space.

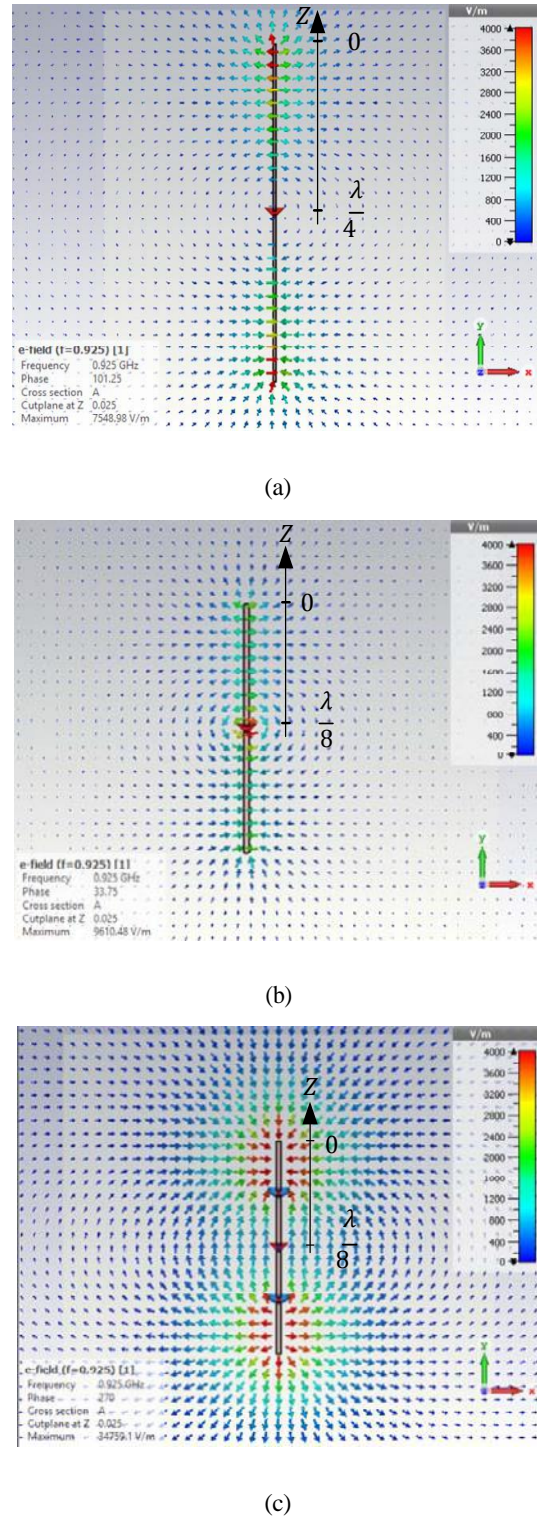




**Fig. 10** Impedance responses with markers at 925.0 MHz for (a) typical  $\lambda/2$  dipole [m1 @  $38.8 + j7.25 \Omega$ ],  $\lambda/4$  dipole [m2 @  $5.05 - j186.76 \Omega$ ], and inductor-loaded  $\lambda/4$  dipole [m3 @  $15.85 + j1.85 \Omega$ ], (b) typical  $\lambda$  loop [m1 @  $91 + j3.35 \Omega$ ],  $\lambda/2$  dipole [m2 @  $22.15 - j526.05 \Omega$ ], and inductor loaded  $\lambda/4$  loop [m3 @  $9.1 + j1.6 \Omega$ ].

Fig. 10(a) shows the simulated impedance responses on the Smith chart for the dipoles. While both the  $\lambda/4$  dipole and the inductor-loading  $\lambda/8$  dipole exhibit a series resonance characteristic, the  $\lambda/4$  dipole possesses a large capacitive reactance. Similarly, for simulations of the loop antennas in Fig. 10(b), the  $\lambda$  loop and the inductor-loaded  $\lambda/2$  loop exhibits a series resonance, whereas the  $\lambda/2$  loop has a high capacitive reactance and close to the parallel resonance mode.

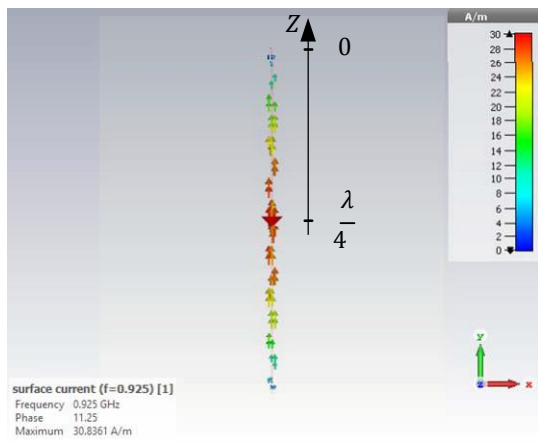
Fig. 11(a) and (b) shows the simulated E fields and current distributions (or equivalently the H fields) of the dipoles and loops, respectively. As evident, all the simulated results are in agreement with the indications from the models in Fig. 7(a) and 7(b), respectively. Note that the z-axes similar to Fig. 5 are also provided to facilitate



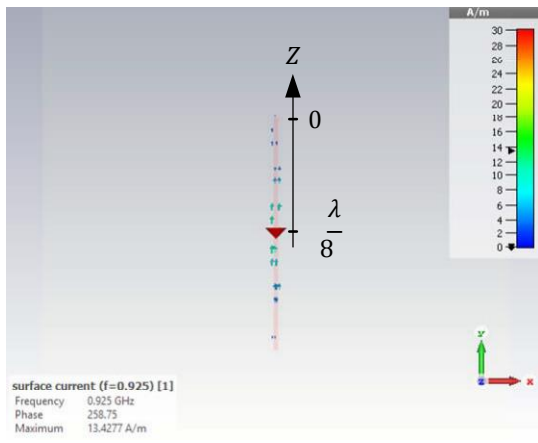
**Fig. 11** E-field distributions for (a) typical  $\lambda/2$  dipole, (b)  $\lambda/4$  dipole and (c)  $\lambda/4$  dipole with inductor loading.

comparison. In particular, the modifications by the inductor loading result in more balanced E and H fields along the antenna structures. This together with relatively small E fields at the inputs indicates the series resonance modes of operation for both the inductor-loaded dipole/loop antennas.

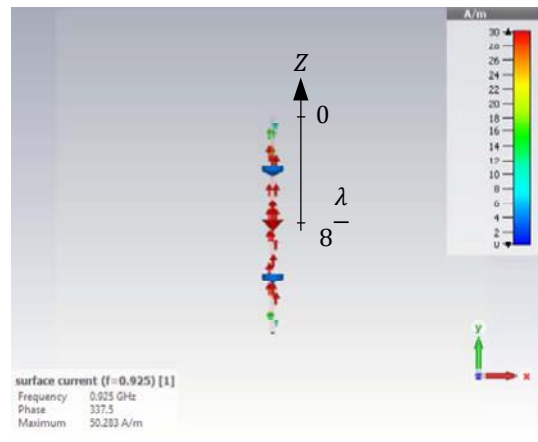




(a)

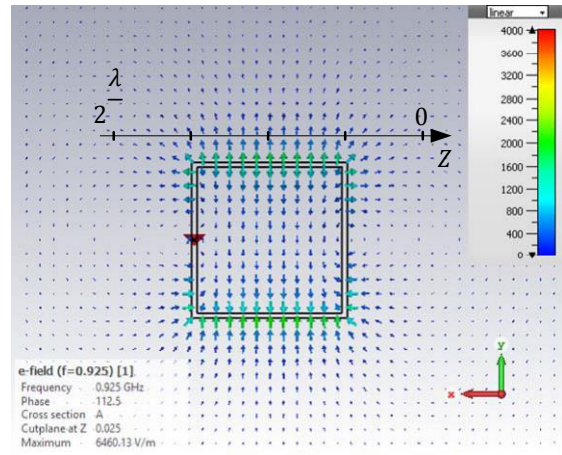


(b)

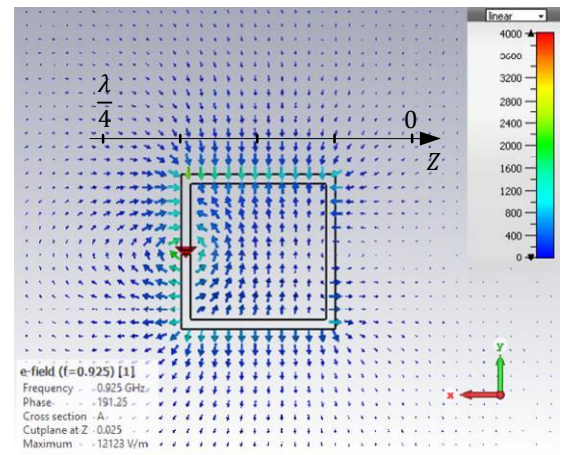


(c)

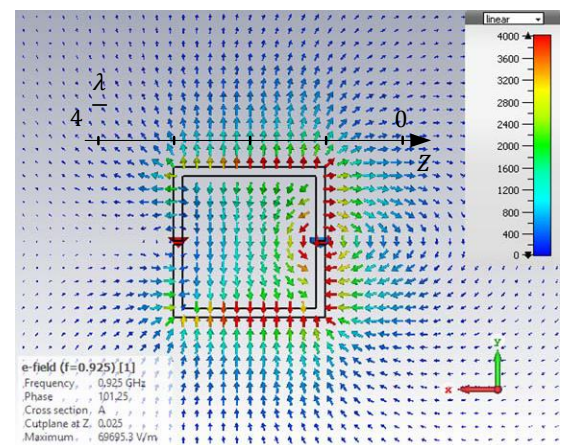
**Fig. 12** Current distributions for (a) typical  $\lambda/2$  dipole, (b)  $\lambda/4$  dipole and (c)  $\lambda/4$  dipole with inductor loading.



(a)



(b)



(c)

**Fig. 13** E-field distributions (a) typical  $\lambda/2$  dipole, (b)  $\lambda/4$  dipole and (c)  $\lambda/4$  dipole with inductor loading.

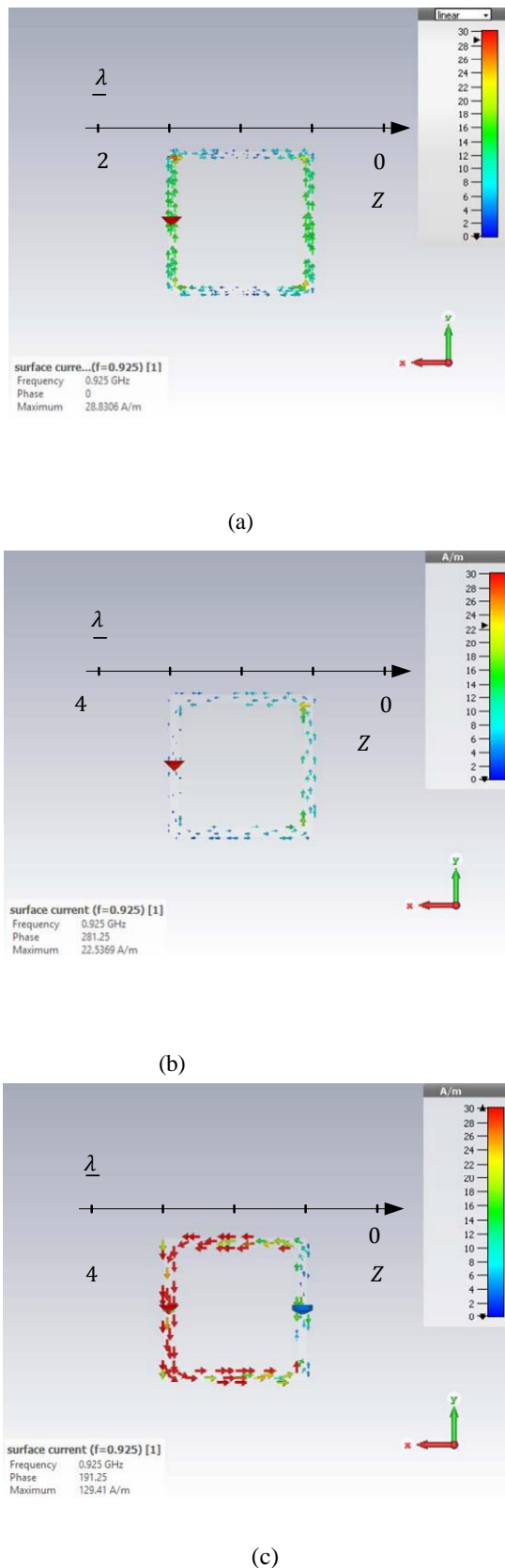
VI. CONCLUSION AND DISCUSSION

The use of the perturbed TWTL as a simplistic model for qualitative identification of the resonance mode of operation and current/voltage or E and H fields distributions along the structures of the dipole and loop antennas has been presented. Its application to gaining insight into the operation of the inductor-loading technique for radiation efficiency improvement in the electrically small dipole/loop antennas has also been given. In essence, the relative phase shift between the incident and reflected waves along the antennas are modified by the inductor loading in such a way that the balance between the E and H fields and/or series-resonance mode are restored. Extensive simulations were provided to verify the utility of the model.

With the ability to predict the E and H field distributions along the antenna structures, another important specification, namely the radiation direction, may also be implied by the model. In addition, the model can also be utilized as an intuitive tool to explore the use of stepped impedance/or capacitive loading in the antennas for other specific applications.

REFERENCES

- [1] Fujimoto, K., & Morishita, H. (2014). *Modern Small Antennas*. Cambridge: Cambridge University Press.
- [2] <https://rudys.typepad.com/files/chapter-4-2.pdf>
- [3] R. Hansen, "Efficiency and Matching Tradeoffs for Inductively Loaded Short Antennas," *IEEE Transactions on Communications*, Vol. 23, No. 4, April 1975, pp. 430-435.
- [4] Balanis, C. A. (2005). *Antenna theory: Analysis and design*, 3<sup>rd</sup> ed., New York: Wiley.
- [5] A. Worpishet, K. Srisathit, W. Surakamptom, "Stepped Impedance Coupled Resonators for Implementation of Parallel Coupled Microstrip Filters With Spurious Band Suppression," *IEEE Transactions on Microwave Theory and Technique*, Vol. 60, No. 6, pp. 1540-1548, June 2012.
- [6] A. Worpishet, "Operational Insight of Microstrip Resonators Using Stepped Impedance Transmission Line and Coupled Lines", *Engineering Transactions*, vol. No., August to December, 2014.
- [7] D. M. Pozar, *Microwave Engineering*, 3<sup>rd</sup> ed., New York: Wiley, 2003.
- [8] CST Student Version, 2016.



**Fig.14** Current distributions(a)typical  $\lambda/2$  dipole,(b)  $\lambda/4$ dipole and (c)  $\lambda/4$  dipole with inductor loading

# Condition Assessment of Synchronous Generator Using Fuzzy Logic

Maninder Choudhary , Thanapong Suwanasri,  
Suphon Kumpalavalee and Phanupong Fuangpian

Electrical and Software System Engineering, The Sirindhorn  
International Thai-German Graduate School of Engineering  
King Mongkut’s University of Technology North Bangkok  
1518 Pracharat 1 Rd., Bangsue, Bangkok, Thailand  
maninder.c-2016epe@tggs.kmutnb.ac.th  
thanapongs@kmutnb.ac.th

Cattareya Suwanasri

Electrical and Computer Engineering,  
Faculty of Engineering  
King Mongkut’s University of Technology North Bangkok  
1518 Pracharat 1 Rd., Bangsue, Bangkok, Thailand  
cattareeya.s@eng.kmutnb.ac.th

**Abstract**—In this paper, a multi-input fuzzy logic system is designed to estimate the health index of synchronous generators used in power system. The system relies on the four diagnostic tests, which are performed on generators to evaluate the condition of insulation. The results obtained from four diagnostic tests i.e. polarization index test, partial discharge test, withstand voltage test and visual inspection are chosen as the input of the fuzzy logic system. The acceptance criteria and membership functions for each input is divided into three linguistic variables; except withstand voltage test, which is divided into two variables. The output of purposed method is health index of generator. The acceptance criteria and membership functions for health index estimation are also divided into three linguistic variables i.e. ‘poor’, ‘moderate’ and ‘good’. Three cases are considered to verify the precision and accuracy of purposed method. The purposed system is very useful tool for utility managers and power plant engineers to monitor the health index of generators and accordingly plan the schedule of preventive maintenance.

**Keywords**— Condition assessment; fuzzy logic; health index; partial discharge; polarzition index; synchornous generators; withstand voltage test

## I. INTRODUCTION

Rotating electric machines are very complex that are subjected to mechanical, electrical, thermal, and environmental stresses of different magnitude. From all components, the insulation system is the most liable to damage or ageing due to these stresses. The health and condition of rotating machine will, therefore, heavily rely on durability of insulation systems [1]. CIGRE study committee SC11, EG11.02 conducted a survey of hydro generator failure in 2013 [2]-[3]. From the results of 69 incidents, it is found that 56% of machine faults caused due to insulation failure, other major types were mechanical, thermal and bearing damages as shown in Fig. 1. The root causes were subdivided into 7 different groups as shown in

Fig. 2. It may be concluded that the insulation failure is a major cause of failure or breakdown of high voltage generators or rotating machines.

The condition-based monitoring of high voltage equipment will not only prevent the system from failure but also optimize the maintenance cost at the same time. Different diagnostic methods are used for precise condition assessment of major components of rotating machines. However, the stator winding insulation system is considered as the critical component of generator as indicated by international surveys and failure statistics [2] shown in Fig. 1 and Fig. 2.

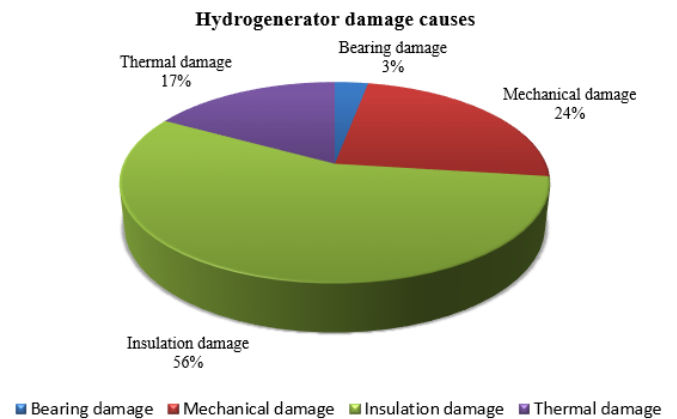


Fig. 1 Cigré Survey on Hydro Generator Failure.

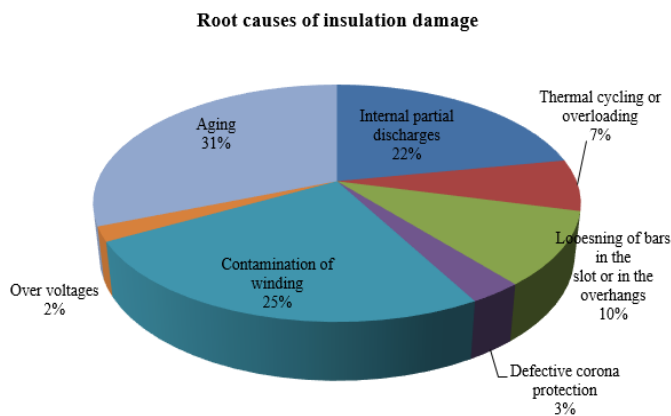


Fig. 2 Root Causes of Insulation Failure.

Various measuring and testing methods, such as insulation resistance test, polarization index test, partial discharge test, dielectric absorption ratio test, dissipation factor test, over voltage test, tan delta measurement and many other diagnostic methods are used to evaluate the condition of insulation in the generators. By examining the measured values, the insulation aging can be pursued. The analysis of measured values play a vital role in insulation assessment.

This paper presents a multi-inputs and multi-criterion fuzzy logic system, which is designed to estimate the health index of generator. The results obtained from four diagnostic tests i.e. insulation resistance/polarization index (PI), partial discharge test (PD), withstand voltage test and visual inspection (VI) are the inputs of purposed system. The health index is output of designed fuzzy system.

## II. INPUTS AND OUTPUT OF FUZZY LOGIC SYSTEM

### A. Inputs of Fuzzy Logic System

In present system, four diagnostic test results are considered as input of fuzzy logic system i.e. PI test, PD test, withstand voltage test and VI test. The diagnostic tests and their acceptance criteria are explained below:

#### 1) Insulation Resistacne/Polarizaion Index Test

PI is the most common method to test the insulation of both stator and rotor windings of generator. The steady DC voltage is applied to the winding; and then current is measured. The ratio of voltage and current gives the resistance of winding. The ratio between winding resistance at 10 minutes and resistance at 1 minute is polarization index as shown in Eq. (1). The insulation resistance IR and PI imply contamination and serious defects within the insulation [4]-[5]. In purposed method, three ranges are set for classification of PI. If the value of resistance ratio  $R_{10min}/R_{1min}$  i.e. PI value is between 0-2, the condition of generator is 'poor'. If the value of resistance ratio  $R_{10min}/R_{1min}$  is 2.1-4, the condition of generator is 'moderate'. If resistance ratio  $R_{10min}/R_{1min}$  is greater than 4, then the condition of machine is 'good'. The acceptance criteria for PI is presented in Table I.

$$PI = \frac{R_{10min}}{R_{1min}} \tag{1}$$

TABLE I ACCEPTANCE CRITERIA OF POLARIZATION INDEX

PI	PI Range	Polarization Index
$R_{10 min}/R_{1min}$	0-2	Poor
	2.1-4	Moderate
	>4	Good

#### 2) Partial Discharge Test

According to IEC 60270 standard, PD is localized electrical discharge that only partially bridges the insulation between conductors, which may or may not occur adjacent to a conductor” [6]. Partial discharge is very useful approach to assess the condition of insulation. There are different types of PD sources as mentioned in IEC/ITS 60034-27-2 [7]. This document not only summarize the PD sources but also score the PD sources in terms of severity. PD is classified into four main categories i.e. internal discharges, slot discharges, end-winding gap and surface discharge and foreign conductive materials discharge [7]. Despite this, the PD measurement is still regularly performed in common practice, data is stored in big or small database and based on condition of evaluated insulation. In general, the reference is made on basis of amplitude of PD and repetition rate [8]-[9]. The PD types, which occur in the generator, are explained as follows.

##### a) Internal Voids

Internal void is a type of internal PD which occurs in the internal parts of the main insulation, mainly in pockets of air or gas. Voids are mainly arising during manufacturing. Usually internal voids are not main cause of aging [7].

##### b) Internal Delamination

Internal delamination occurs in areas of gas or air and it is extended vertically and induced in internal parts of primary insulation. The main causes of internal delamination are overheating, thermal or mechanical stress, which further causes the separation of insulation layers [7].

##### c) Conductors and Insulation Internal Delamination

Internal delamination is also the type of internal PD that occurs between the conductors and insulation material. Long term thermal or mechanical stress is main cause of delamination effect. The separation between insulation layers occurs due to the internal delamination [7].

##### d) Slot Discharges

Slot discharge occurs due to the loose or lost contact between slot coating and stator slot wall. Conductive coating may be damaged by the high local resistance and vibration. If the coating of conductor is too conductive, the vibration which is produced by electromagnetic forces on loosen coil further triggers the spark producing discharges within the slots [7].



*e) Surface and End Winding Gap Discharges*

Surface and end winding gap discharges caused by the conductive impurities or contamination i.e. dust, oil, etc. or from damaged material. Discharges occur at surface near end winding area of machine. Surface discharges usually do not cause the indicative ageing but the presence of high contamination can accelerate the aging process [7].

*f) Contamination*

The existence of impurities contaminates the insulation surface near the end-winding which results in PD. Although it is not the main cause of ageing, it can make aging process faster [7].

All PD types have their own impact on the generators; however, the internal delamination between the insulation and conductors (coil winding), and slot discharges (loose winding) are considered as severe type of PD having high impact on ageing. The internal delamination between the insulation and conductors (bar windings), internal delamination, slot discharge (tight winding) end winding gap and surface discharges have moderate impact on ageing whereas the internal voids has low impact on ageing [7]. In purposed method, three ranges are set based on the severity of PD as shown in Table II. The 0-50 range is set for ‘severe PD’, 50-80 range is set for the ‘moderate PD’ and 80-100 range is set for ‘no PD’. The user can select any crisp input to represent type of PD based on severity. The acceptance criteria for PD is defined in Table II.

**TABLE II ACCEPTANCE CRITERIA OF PARTIAL DISCHARGE**

Range	Severity	PD Type
0-50	Severe	Internal delamination between the insulation and conductors (coil winding)
		Slot discharges (loose winding)
51-80	Moderate	Internal voids
		Internal delamination between the insulation and conductors (Bar windings)
		Internal delamination slot discharge (tight winding)
		Contamination
		End winding gap and surface discharges
81-100	No PD	No PD

*3) Withstand Voltage Test*

Withstand voltage test or high potential (High potential) test involves the application of high voltage between conductor of winding and ground. High potential test is intended to detect insulation fault, which can cause failure of insulation during service or in the future. The sole purpose is to assure that motor or generator can operate while the main ground insulation in those windings can be placed in service with little

risk of a failure [10]. Three types of high potential tests are performed on insulation system of electric machines i.e. AC high potential test with power system frequency, AC high potential test with low frequency of 0.1 HZ and DC high potential [11]. High potential test is performed to provide some assurance that winding unlikely to suffer an insulation failure. It follows ‘pass’ and ‘fail’ criteria. In purposed method, the 0 is set for ‘fail’ and 1 is set for ‘pass’. If the generator fails the high potential test, an invasive repair and retest is required before the generator can return to service if the winding does not withstand the test voltage. The acceptance criteria for high potential test are defined in Table III.

**TABLE III ACCEPTANCE CRITERIA FOR HIGH POTENTIAL TEST**

Range	High potential Test
0	Fail
1	Pass

*4) Visual Inspection*

Visual inspection (VI) plays an important role in condition monitoring of electrical equipment. VI of generators can detect surface flaws like cracks, porosity, surface finish, rusting and corrosion [12]. It can also identify the contamination, dust or oil on the surface of winding or generator, which can further lead to the surface discharge. In purposed method, the 0-50 range is set to represent ‘poor condition’ of generator, 50-80 is set for the ‘moderate condition’, and 80-100 is set for ‘good condition’ of generator during visual inspection. The acceptance criteria and type of fault for visual inspection are defined in Table IV.

**TABLE IV ACCEPTANCE CRITERIA FOR VISUAL INSPECTION**

Range	Type of Fault	Visual Inspection
0-50	High contamination, cracks, porosity, rust and corrosion	Poor condition
50-80	Low contamination, cracks, porosity, rust and corrosion	Moderate condition
80-100	No contamination, cracks or porosity	Good condition

*B. Output of Fuzzy Logic System*

2) In purposed system, only one output is considered i.e. health index of generator.

The Health index (HI) is a practical tool, which tells the wellbeing of a machine whether it’s in ‘poor’, ‘moderate’ or ‘good’ condition. It combines the results of diagnostic tests performed on the asset, field inspections as well as site and laboratory testing into an objective and quantitative index, providing the overall health of the asset. The HI is a powerful tool for managing assets and identifying investment needs as well as prioritizing investments in capital and maintenance



programs [13] [14]. Many utilities around the world use web based application for condition assessment and HI calculation. In this paper a fuzzy logic-based system is designed which tell the HI of generator using different diagnostic test's results performed on generator for insulation assessment taken into consideration. In purposed method, the 0-50 range is set for 'poor', 50-80 range is set for the 'moderate' and 80-100 range is set for 'good' health index of generator. The acceptance criteria for HI are defined in Table V.

TABLE V ACCEPTANCE CRITERIA FOR HEALTH INDEX

Range	Health Index
0-50	Poor
51-80	Moderate
81-100	Good

### III. METHODOLOGY

#### A. Designing Fuzzy Logic System

The fuzzy logic system is designed in MATLAB program. The system is used for the condition evaluation of generator, mainly insulation. The fuzzy inference system (FIS) is designed mentioning the inputs and output of the system. In this system, four diagnostic tests results are considered as input of the FIS system i.e. the results from PI test, PD test, high potential test and VI test whereas the output of the system is health index as shown in Fig. 3.

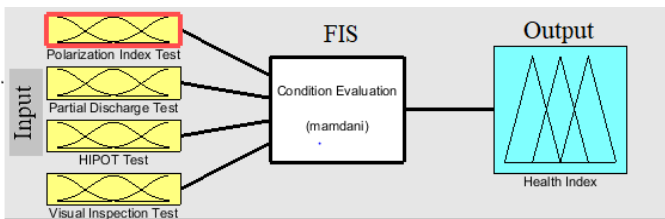


Fig. 3 Fuzzy Inference System (FIS).

#### B. Operation of Fuzzy Logic System

The operation of fuzzy logic system is based on three major processes i.e. 1) Fuzzification, 2) Fuzzy Inference and 3) Defuzzification. The Fig. 4 shows the block diagram of operation of fuzzy system [15]. The step by step operation of fuzzy logic system is explained below:

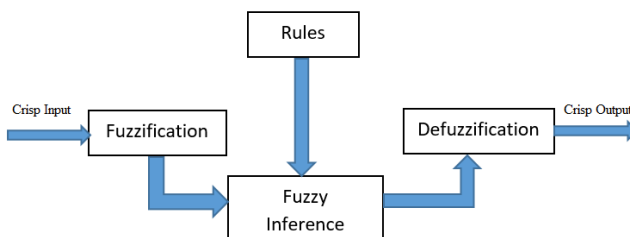


Fig. 4 Fuzzy Inference System Operation Block Diagram.

#### C. Fuzzification

Fuzzification is a process, which converts the crisp input values into fuzzy sets using suitable membership function (MF) [15]. The crisp input is a value, which is entered by the user. In the present work, triangular membership function is selected to represent each diagnostic test range. As it is more simple and suitable than Gaussian and trapezoidal shaped, MFs for this system [16]. Fig. 5 shows the triangular membership function with lower limit, center limit and upper limit of 1, 1.5 and 2 respectively.

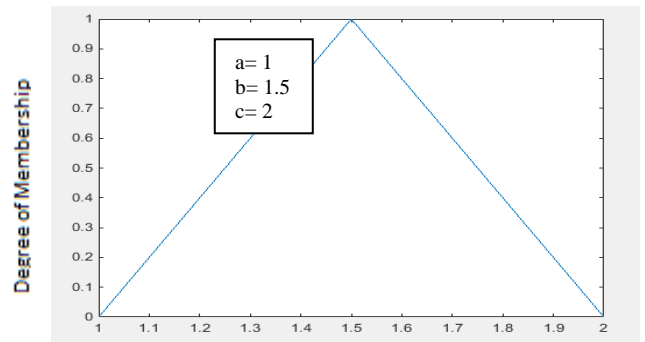


Fig. 5 Triangular Membership Function

The triangular membership function [15] is modeled by the Eq. (2).

$$f(x; a, b, c) = \begin{cases} 0, & x \leq a \\ \frac{x-a}{b-a}, & a \leq x \leq b \\ \frac{c-x}{c-b}, & b \leq x \leq c \\ 0, & c \leq x \end{cases} \quad (2)$$

where 'x' is the input, 'a' and 'c' are the lower and upper limits of MF i.e. the base of the triangle and 'b' is the peak or midpoint of the triangle [11]. If 'x' is less than or equal to 'a', degree of MF is zero. If 'x' is greater than or equal to 'a' but less than equal to 'b', then value of MF can be calculated by  $\frac{x-a}{b-a}$ . If the 'x' is greater than or equal to 'b' but less than equal to 'c' then the degree of MF can be calculated by  $\frac{c-x}{c-b}$ . If the value of 'x' is greater than 'c', then value of MF becomes zero. The inputs at point 'b' of the MF gain a maximum degree of membership (DOM) of unity. On the other hand, the inputs between 'a' and 'b', or 'b' and 'c' have DOM less than unity as shown in Fig. 5. Therefore, the fuzzy converts the input from precise to fuzzy (imprecise value), between 0 and 1, using Eq. (2). Table VI defines the lower, center and upper limits of all MFs used in purposed fuzzy system.

TABLE VI LOWER, CENTER AND UPPER LIMITS OF ALL MFs

Parameters		Lower, Center and Upper limits of all Membership functions			
		MF's	a	b	c
Input	PI Test	Poor	-1	0	2.5
		Moderate	1.5	3	4.5
		Good	3.5	5	6.5
	PD Test	Severe PD	-1	0	50.5
		Moderate PD	50.5	65.5	80.5
		NO PD	80.5	90.5	100.5
	High potential Test	Pass	-0.5	1	1.5
		Fail	-1.5	-0.5	0.5
	VI Test	Poor condition	-0.5	25	50.5
		Moderate condition	50.5	65.5	80.5
Good condition		80.5	90.5	100.5	
Output	HI	Poor	-1	0	50.5
		Moderate	50.5	65.5	80.5
		Good	80.5	90.5	100.5

D. Membership Functions

1) Membership Functions for PI Test

The MFs for polarization index are divided into three linguistic variables: ‘poor’, ‘moderate’ and ‘good’. Three triangular MFs are chosen to model the PI acceptance ranges as given in Table I. The lower, center and upper limits of each MF are given in Table VI. Fig. 6 shows the graphical representation of MFs used for PI test. It can be seen that the value of ‘a’ is 1.5, ‘b’ is 3 and ‘c’ is 4.5 for ‘moderate’ MF. Each MF is overlapped by a value of 0.5.

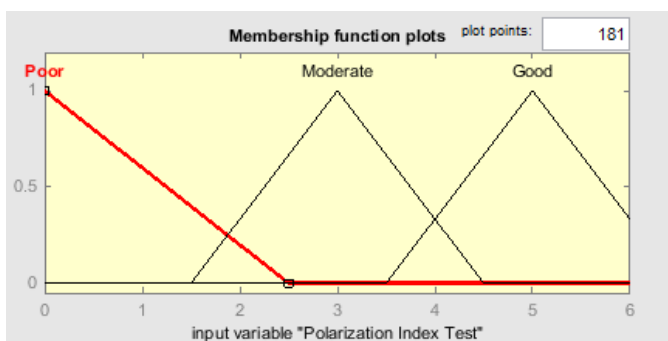


Fig.6 Membership Functions for Polarization Index Test.

2) Membership Functions for PD Test

The MFs for PD are divided into three linguistic variables: ‘severe PD’, ‘moderate PD’ and ‘no PD’. Three triangular MFs are chosen to model the acceptance ranges of PD as given in Table II. The lower, center and upper limits of each

MF are given in Table VI. Fig. 7 shows the graphical representation of MFs used for PD test. It can be seen that the value of ‘a’ is 50.5, ‘b’ is 65.5 and ‘c’ is 85.5 for ‘moderate’ MF. Each MF is overlapped by the value of 0.5.

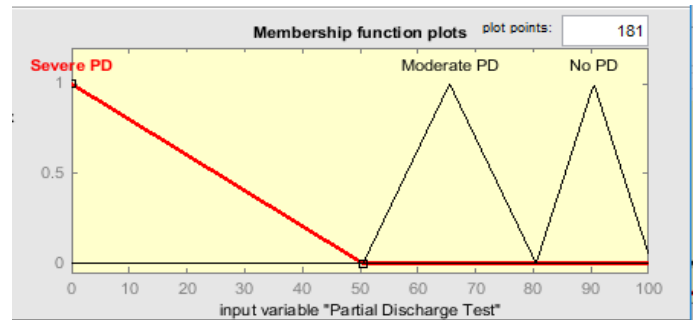


Fig. 7 Membership Functions for PD Test.

3) Membership Functions for Withstand Voltage Test

The MFs for withstand voltage or high potential test are divided into two linguistic variables: ‘pass’ and ‘fail’. Since high potential test follows the ‘pass’ or ‘fail’ criteria hence two triangular are chosen to model the high potential test based on the acceptance criteria defined in Table III. The lower, center and upper limits of each MF are given in Table VI. Fig. 8 shows the graphical representation of MFs used for high potential test. It can be seen that the value of ‘a’ is -0.5, ‘b’ is 1 and ‘c’ is 1.5 for ‘pass’ MF. Each MF is overlapped by the value of 0.5.

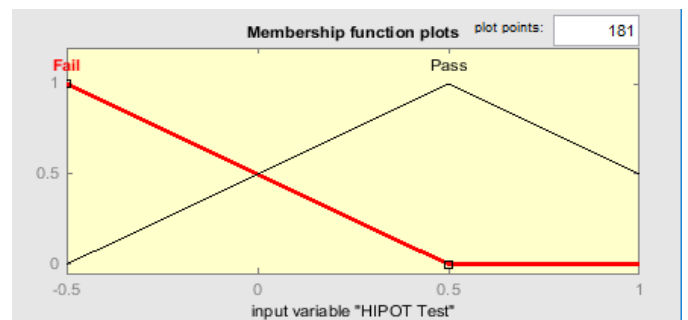


Fig. 8 Membership Functions for High Potential Test.

4) Membership Functions for Visual Inspection Test

The MFs for VI test are divided into three linguistic variables: ‘poor condition’, ‘moderate condition’ and ‘good condition’. Three triangular MFs are chosen to model the acceptance ranges of VI test as given in Table IV. The lower, center and upper limits of each MF are given in Table VI. Fig. 9 shows the graphical representation of MFs used for PD test. It can be seen that the value of ‘a’ is 50.5, ‘b’ is 65.5 and ‘c’ is 85.5 for ‘moderate’ MF. Each MF is overlapped by the value of 0.5.

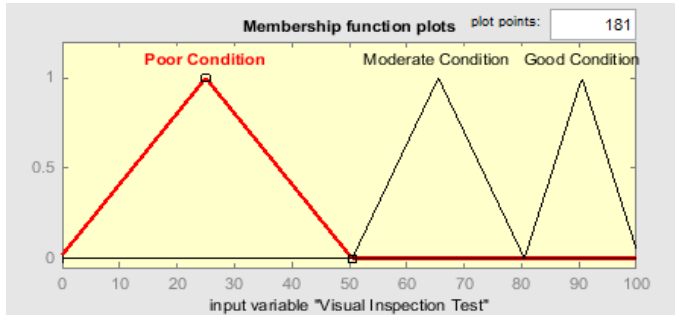


Fig. 9 Membership Functions for Visual Inspection Test.

5) Membership Functions for Health Index

The MFs for health index are divided into three linguistic variables: ‘poor’, ‘moderate’ and ‘good’. Three triangular MFs are chosen to model the acceptance ranges of health index as given in Table V. The lower, center and upper limits of each MF are given in Table VI. Fig. 10 shows the graphical representation of MFs used for health index. It can be seen that the value of ‘a’ is 50.5, ‘b’ is 65.5 and ‘c’ is 85.5 for ‘moderate’ MF. Each MF is overlapped by the value of 0.5.

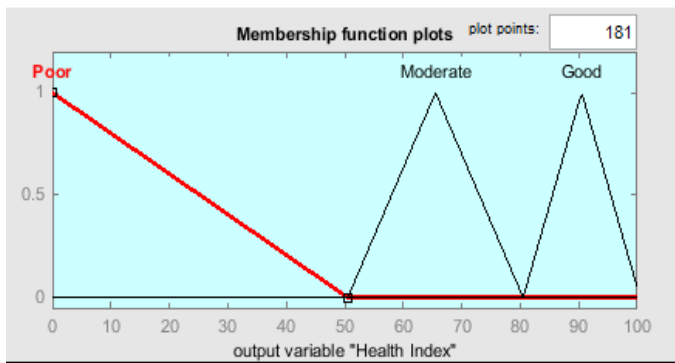


Fig. 10 Membership Functions for Health Index.

To understand the designed FL method in detail. Let’s assume that the values of PI, PD, high potential and VI are 4.3, 88, 1 and 87, respectively. The corresponding MFs for inputs PI, PD, high potential and VI as per given crisp inputs are ‘good’, ‘no PD’, ‘pass’ and ‘good condition’ with DOM 0.19, 0.75, 1 and 0.65 respectively as mentioned in Table VII. The corresponding MF for health index based on the fuzzy inputs is found in fuzzy inference stage.

TABLE VII FUZZIFICATION

Input Type	Crisp Input	MFs	Calculation	DOM
PI	4.3	Good	$\frac{4.3 - 3.5}{5 - 3.5}$	0.5
PD	88	No PD	$\frac{88 - 80.5}{90.5 - 80.5}$	0.75
High potential	1	Pass	$\frac{1 - (-0.5)}{1 - (-0.5)}$	1
VI	87	Good Condition	$\frac{87 - 80.5}{90.5 - 80.5}$	0.65

E. Fuzzy Inference

It’s mentioned in [17] that ‘m’ inputs each with ‘n’ MFs would generate a total of  $n_1 \times n_2 \times n_3 \times \dots \times n_m$  combinations where  $n_1, n_2, n_3, \dots, n_m$  are the number of MFs of inputs and 1,2,3,.....,m, respectively. In the purposed system, 4 inputs each with 3 MFs, except high potential test containing 2 MFs, have the total 11 MFs. The possible number of combinations are  $3 \times 3 \times 2 \times 3 = 54$ . However, in purposed system only 28 rules are considered based on the expert opinion. The “If and Then Rules” are considered for fuzzy inference as follows.

If and Then Rules

1. **If** high potential test is ‘fail’, **then** health index is ‘poor’.
2. **If** PI is ‘good’ and PD is ‘no PD’ and high potential test is ‘pass’ and VI is ‘good condition’, **then** HI is ‘good’.
3. **If** PI is ‘good’ and PD is ‘no PD’ and high potential test is ‘pass’ and VI is ‘moderate condition’, **then** HI is ‘good’.
4. **If** PI is ‘good’ and PD is ‘no PD’ and high potential test is ‘pass’ and VI is ‘poor condition’, **then** HI is ‘moderate’.
5. **If** PI is ‘good’ and PD is ‘moderate PD’ and high potential test is ‘pass’ and VI is ‘good condition’, **then** HI is ‘good’.
6. **If** PI is ‘good’ and PD is ‘moderate PD’ and high potential test is ‘pass’ and VI is ‘moderate condition’, **then** HI is ‘good’.
7. **If** PI is ‘good’ and PD is ‘moderate PD’ and high potential test is ‘pass’ and VI is ‘poor condition’, **then** HI is ‘moderate’.
8. **If** PI is ‘good’ and PD is ‘severe PD’ and high potential test is ‘pass’ and VI is test ‘good condition’, **then** HI is ‘moderate’.
9. **If** PI is ‘good’ and PD is ‘severe PD’ and high potential test is ‘pass’ and VI is ‘moderate condition’, **then** HI is ‘moderate’.

10. **If** PI is ‘good’ and PD is ‘severe PD’ and high potential test is ‘pass’ and VI is ‘poor condition’, **then** HI is ‘moderate’.
11. **If** PI is ‘moderate’ and PD is ‘no PD’ and high potential test is ‘pass’ and VI is ‘good condition’, **then** HI is ‘good’.
12. **If** PI is ‘moderate’ and PD is ‘no PD’ and high potential test is ‘pass’ and VI is ‘moderate condition’, **then** HI is ‘good’.
13. **If** PI is ‘moderate’ and PD is ‘no PD’ and high potential test is ‘pass’ and VI is ‘poor condition’, **then** HI is ‘good’.
14. **If** PI is ‘moderate’ and PD is ‘moderate PD’ and high potential test is ‘pass’ and VI is ‘good condition’, **then** HI is ‘good’.
15. **If** PI is ‘moderate’ and PD is ‘moderate PD’ and high potential test is ‘pass’ and VI is ‘moderate condition’, **then** HI is ‘moderate’.
16. **If** PI is ‘moderate’ and PD is ‘moderate PD’ and high potential test is ‘pass’ and VI is ‘poor condition’, **then** HI is ‘moderate’.
17. **If** PI is ‘moderate’ and PD is ‘severe PD’ and high potential test is ‘pass’ and VI is ‘good condition’, **then** HI is ‘moderate’.
18. **If** PI is ‘moderate’ and PD is ‘severe PD’ and high potential test is ‘pass’ and VI is ‘moderate condition’, **then** HI is ‘moderate’.
19. **If** PI is ‘moderate’ and PD is ‘severe PD’ and high potential test is ‘pass’ and VI is ‘poor condition’, **then** the HI is ‘moderate’.
20. **If** PI is ‘poor’ and PD is ‘no PD’ and high potential test is ‘pass’ and VI is ‘good condition’, **then** HI is ‘moderate’.
21. **If** PI is ‘poor’ and PD is ‘no PD’ and high potential test is ‘pass’ and VI is ‘moderate condition’, **then** HI is ‘moderate’.
22. **If** PI is ‘poor’ and PD is ‘no PD’ and high potential test is ‘pass’ and VI is ‘poor condition’, **then** HI is ‘poor’.
23. **If** PI is ‘poor’ and PD is ‘moderate PD’ and high potential test is ‘pass’ and VI is ‘good’, **then** HI is ‘moderate’.
24. **If** PI is ‘poor’ and PD is ‘moderate PD’ and high potential test is ‘pass’ and VI is ‘moderate condition’, **then** HI is ‘moderate’.
25. **If** PI is ‘Poor’ and PD is ‘moderate PD’ and high potential test is ‘pass’ and VI is ‘poor condition’, **then** HI is ‘poor’.
26. **If** PI is ‘poor’ and PD is ‘severe PD’ and high potential test is ‘pass’ and VI is ‘good condition’, **then** HI is ‘poor’.

27. **If** PI is ‘poor’ and PD is ‘severe PD’ and high potential test is ‘pass’ and VI is ‘moderate condition’, **then** the HI is ‘poor’.
28. **If** PI is ‘poor’ and PD is ‘severe PD’ and high potential test is ‘pass’ and VI is ‘poor condition’, **then** the HI is ‘Poor’.

The details of rules are explained above. The FL rules are depending on the input and output of MFs and can be found in [17]-[18]. The Mamdani maximum and minimum Fuzzy inference method is most commonly used by expert to determine the HI of HV equipment [19].

As seen from Fig. 12, rule 2 is executed. The inputs and corresponding MFs are given in Table VII. Whereas rule 11 is executed by ‘moderate’, ‘no PD’, ‘pass’ and ‘good condition’ MFs. It can be seen in Fig. 12 that the output MF for rule 2 has low DOM value and output MF for rule 11 has high DOM value. But the total area bounded by the output MFs of rules 2 and 11 is defuzzified to determine the final crisp output, i.e. health index of generators. The details are given in the defuzzification stage of the model. It can be seen in Fig. 12 the MF for remaining 26 fuzzy rules is zero, for the same set of inputs. It means that the given crisp inputs do not lie within the range of 26 fuzzy rules.

#### F. Defuzzification

In present system, the center of gravity method, which is the most popular method, is used for the defuzzification. It determines the center of gravity point ( $Z_0$ ) of the area bounded by the truncated output MFs. The COG point is obtained by applying Eq. (3) [18].

$$Z_0 = \frac{\int z \cdot \mu(z) \cdot dz}{\int \mu(z) \cdot dz} \quad (3)$$

Where ‘z’ is output variable and ‘ $\mu(z)$ ’ is DOM of the truncated output MF. Fig. 11 [19] shows the defuzzification method in accordance with rule no 2. It can be seen that the output is in between the range of 80-100, which represent ‘good’ condition of generator.

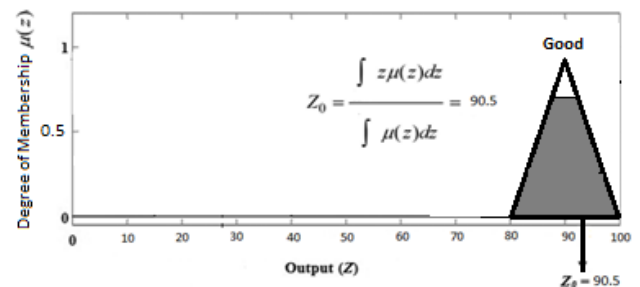


Fig. 11 Determination of HI of Generator by Using Centroid Method.

#### IV. CASE STUDIES

Three cases are considered to test the purposed fuzzy logic system. The crisp inputs are feed into fuzzy system and corresponding health index is obtained as output as presented in Table VIII.

TABLE VIII 3 GENERATORS AS CASE STUDIES

Test Results as Inputs					Output
No.	PI Test	PD Test	High potential Test	VI Test	HI
Gen-1	1.5	23	1	35	20.4
Gen-2	1.8	91	1	70	73.8
Gen-3	4.5	85	1	84	90.5

Gen No.1: In the first case, the input values of PI test, PD test, high potential test, and VI test are 1.5, 23, 1 and 35 respectively. The corresponding MFs of PI, PD, high potential and VI test are ‘poor’, ‘severe PD’, ‘pass’ and ‘poor condition’. The Fig. 13 shows the fuzzy inference diagram. It can be seen that health index value is 20.4. This implies that the condition of generator is ‘poor’.

Gen No.2: In the second case the input values of PI test, PD test, high potential test, and VI test are 1.8, 91, 1 and 70 respectively as given in the Table VII. The corresponding MFs of PI, PD, high potential and VI tests are ‘poor’, ‘no PD’, ‘pass’ and ‘moderate condition’. The Fig. 14 shows the fuzzy inference diagram. It can be seen that health index value is 73.8. This implies that the condition of generator is ‘moderate’.

Gen No.3: In the third case the input values of PI test, PD test, high potential test, and VI test are 4.5, 85, 1 and 84 respectively as given in the Table VII. The corresponding MFs of PI, PD, high potential and VI test are ‘good’, ‘no PD’, ‘pass’ and ‘good condition’. The Fig. 15 shows the fuzzy inference diagram. It can be seen that the health index value is 90.5. This implies that the condition of generator is ‘good’.

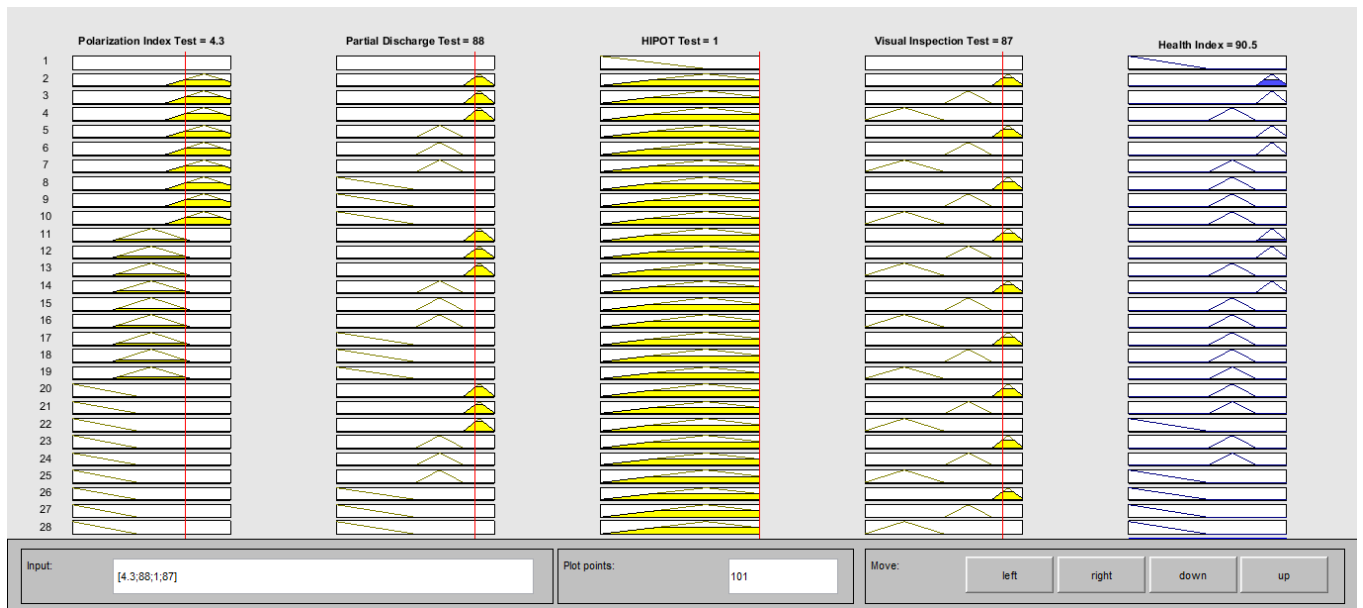
V. CONCLUSION

The present paper proposes a multi-variable fuzzy logic-based system which determines the health of generator. The major diagnostic test parameters are incorporated in this system to determine the health of the equipment. Four inputs i.e. polarization index, partial discharge, high potential test and visual inspection are considered, and their acceptance criteria are divided into three categories namely ‘poor’, ‘moderate’ and ‘good’. Three case studies are also considered to test the efficiency of the purposed FL system. Although it’s more reliable method however the system can be optimized by adding more test parameters and applying more sophisticated artificial intelligence techniques.

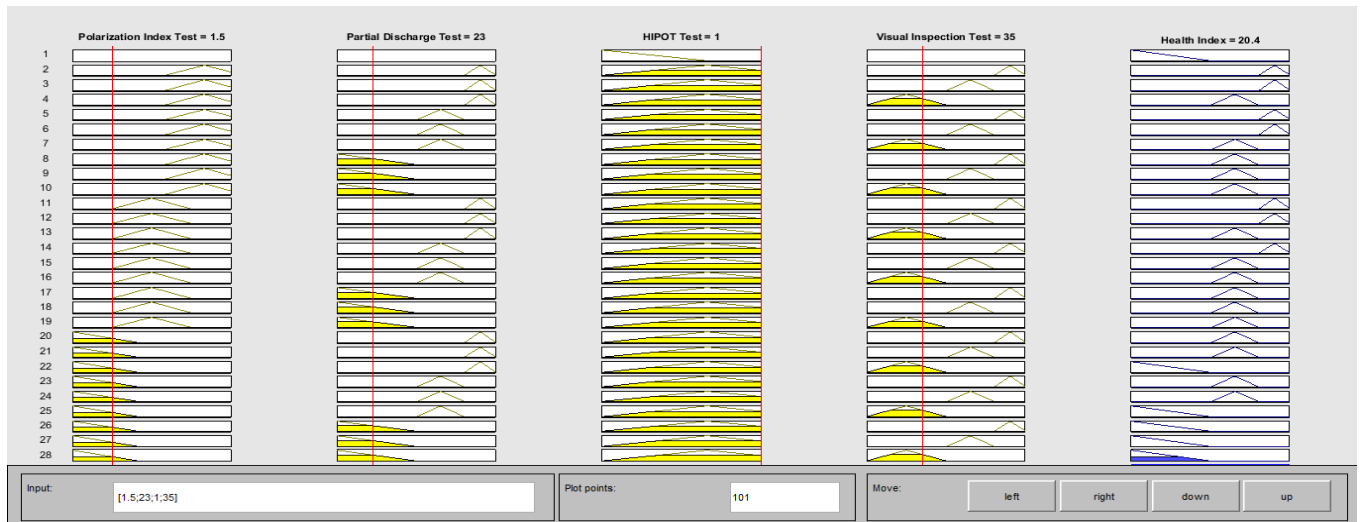
II. REFERENCES

- [1] IEEE Std 26-2016. “IEEE Guide for Insulation Maintenance of Electrical Machine”, 2016.
- [2] CIGRE Study Committee SC11, EG11.02, “Hydrogenerator Failures – Results of the Survey”, 2003.
- [3] R. Brüttsch., M. Tari., K. Fröhlich., T. Weiers. and R. Vogelsang., “Insulation failure mechanisms of power generators”, *IEEE Electrical Insulation Magazine*, vol.24, no.4, pp. 17-25, 2008.
- [4] IEEE Std 43-2000. “IEEE Recommended Practice for Testing of Insulation Resistance of Rotating Machinery”, 2000.
- [5] IEEE std 62.2. “IEEE Guide for Diagnostic Field Testing of Electrical Apparatus- Electrical Machinery”, 2004
- [6] IEC-60270. “High-Voltage Test Techniques - Partial Discharge Measurements”, 2015.
- [7] IEC 60034-27-1. “Rotating Electrical Machines Offline Partial Discharge Measurements on Winding Insulation”, 2017.
- [8] I. Blokhintsev., J. Kozusko., B. Oberer. and D. Anzaldi., “Simple statistical approach presenting partial discharge data in large pool of MV motors in continuous and remote PD monitoring system”, in *IEEE Electrical Insulation Conference (EIC)*, Baltimore MD, 2017.
- [9] G. C. Stone, C. Chan, and H. G. Sedding., “Online Partial Discharge Measurement in Hydrogen- Cooled Generators”, in *IEEE Electrical Insulation Conference (EIC)*, Montréal, Qc, Canada, 2016.
- [10] G. C. Stone and Ilie Relu, “Turbine generator rotor and stator winding hipot testing”, *IEEE Electrical Insulation Magazine*, vol. 28, no. 2, pp. 29-37, 2012.
- [11] B. Gupta, G. Stone and J. Stein, “Stator Winding Hipot (High Potential) Testing”, 2009.
- [12] Geoff Klempner., Isidor Kerszenbaum.,: *Handbook of Large Turbo-Generator Operation and Maintenance*, New Jersey: John Wiley & Sons, Inc., Hoboken, 2004.
- [13] T. Hjartarson and Shawn Otal, “Predicting future asset condition based on current health index and maintenance level”, in *11th IEEE Conf. Transmission & Distribution Construction, Operation and Live-Line Maintenance*, 2006.
- [14] A. Naderian, S. Cress., R. Piercy., F. Wang. and J. Service., “An approach to determine the health index of power transformer”, in *Proc. IEEE Int. Symp. Electrical Insulation*, 2008.
- [15] J.M. Mendel., “Fuzzy logic systems for engineering: a tutorial”, *Proceedings of the IEEE*, vol. 83, no. 3, pp. 345 - 377, 1995.
- [16] H. Putri. and Robbi Rahim., “Comparative Analysis of Membership Function on Mamdani”, in *International Conference on Information and Communication Technology (IconICT)*, 2017.
- [17] F. O. Karry. and C. De Silva.: *Soft computing and intelligent systems design: theory and applications*, Newyork: Pearson/Addison-Wesley, 2004.
- [18] N. Nedjah and De Macedo Mourelle Luzia., *Fuzzy systems engineering theory and practice*, Springer, 2005.
- [19] C. Ranga, A. K. Chandel. and Rajeevan Chandel., “Condition Assessment of Power Transformers Based on Multi-Attributes Using Fuzzy Logic”, *Institution of Engineering & Technology Journals*, vol. 11, no. 8, pp. 983-990, 2017.





*Fig. 12 Fuzzy Inference Diagram for Rule no. 2 and Rule no.11.*



*Fig. 13 Fuzzy Inference Diagram for Gen no.1 and Execution of Rule no 28.*



*Fig. 14 Fuzzy Inference Diagram for Gen no. 2 and Execution of Rule no. 12 and 21.*



*Fig. 15 Fuzzy Inference Diagram for Gen no. 3 and Execution of Rule no. 2.*

## **IEET Editorial Office**

**EAAAT - Electrical Engineering Academic Association (Thailand)**  
**Room 409, F-Building**  
**140 Cheum-Sampan Rd.**  
**Nong Chok, Bangkok, Thailand 10530**  
**Tel: +662-988-3655 ext 2216 Fax: +662-988-4026**

**[www.journal.eeat.or.th](http://www.journal.eeat.or.th)**

